

Operator's Manual

Colleague CXE

VOLUMETRIC INFUSION PUMP

Colleague 3 CXE

VOLUMETRIC INFUSION PUMP

PRODUCT CODES: 2M91617A and 2M91637A

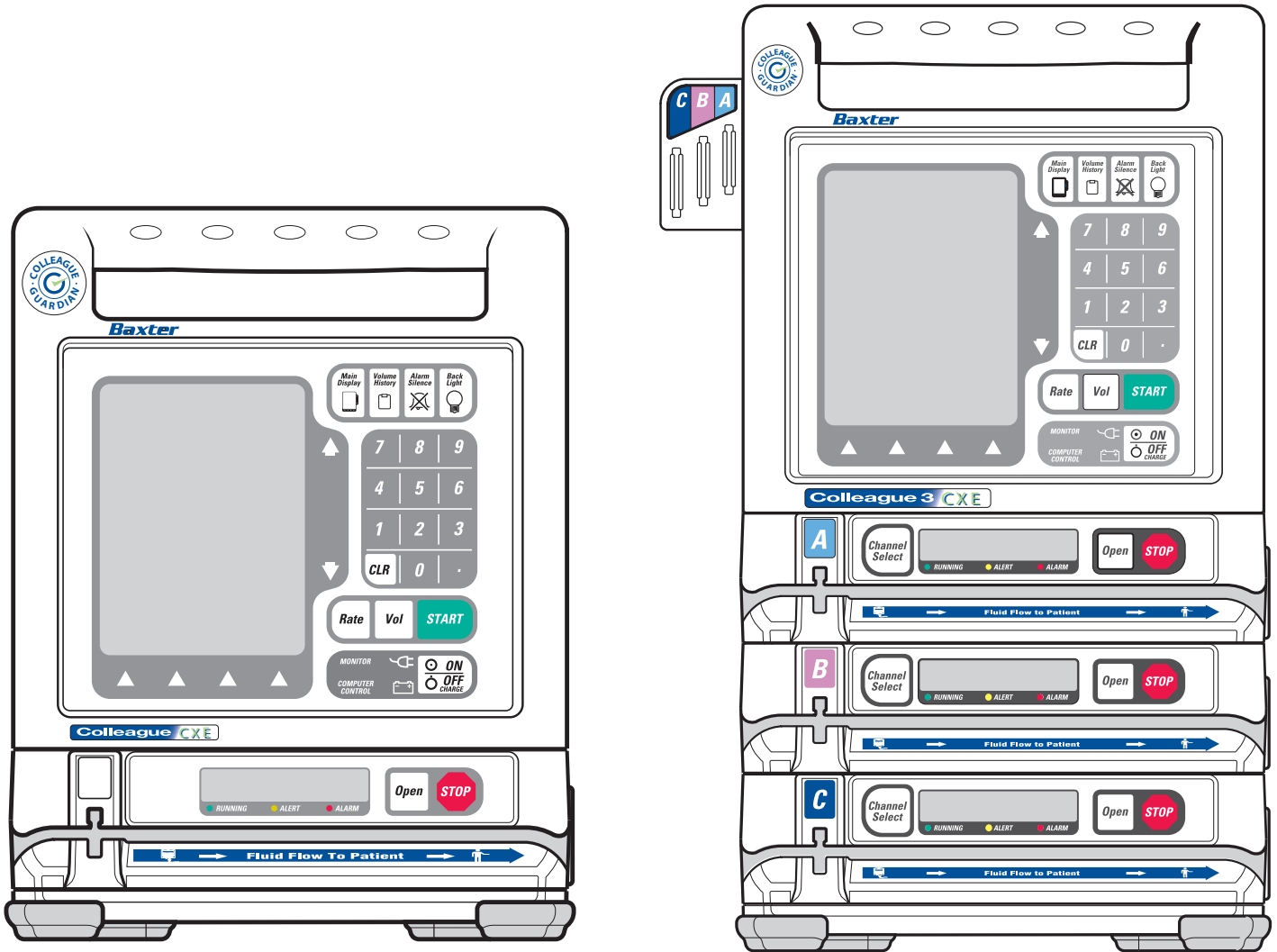

Baxter

Prior to using this pump, read this manual carefully to fully understand the pump's functionality and to ensure safe and proper operation.

CD071968806

! WARNING !

There are risks associated with using anything other than the recommended sets with this device. Sets designated for use with this device are identified in “Recommended Administration Sets,” 4-15. Baxter’s warranty on this device will be null and void and Baxter will assume no responsibility for incidents which may occur if the product is not used in accordance with product labeling.

Computer Software Copyrights

©Copyright 1996 – 2013, Baxter Healthcare Corporation. All rights reserved.

For use only by Baxter Healthcare Corporation. The software contains proprietary information belonging to Baxter Healthcare Corporation. The software must not be reproduced or disclosed to others without prior written approval. Any unauthorized use of this information may subject the user to substantial liability.

Documentation Copyrights

Duplication or distribution of this manual and any information contained within is strictly prohibited without the express written permission of Baxter. This manual and any information contained within, may not be reproduced, distributed, or transmitted in any form, or by any means, for any purpose, without the express written permission of Baxter. To order additional copies of this manual, or other related manuals, contact your local Baxter Service Center.

Disclaimer

The information in this document has been carefully examined and is believed to be entirely reliable. However, no responsibility is assumed for inaccuracies. Furthermore, Baxter reserves the right to make changes to any products herein to improve readability, function, or design. Baxter does not assume any liability arising out of the application or use of any product or circuit described herein; neither does it cover any license under its patent rights nor the rights of others.

Trademark Information

Baxter, Buretrol, Colleague, Colleague Guardian, Continu-Flo and Personality are trademarks of Baxter International Inc. Any other trademarks, products, brands or images appearing herein are the property of their respective owners.

Patent Information

This device is protected under one or more of the following U.S. and foreign patents: United States: 5151019, 5764034, 5779207, 5782805, 5842841, 6013057, 6123524, D390654, RE37074E, 2004/0193325A1; Australia: 130693, 706187, 710286, 712859, 713132, 721076, 740655; Austria: E248618, E255925; Belgium: EP0833674, EP0836492, EP0837708, EP0891784; Canada: 2223838, 2223841, 2223897, 80218; Denmark: 165/97, EP0833674, EP0836492, EP0837708, EP0891784; European Patent Convention: EP0833674; Finland: EP0836492, EP0891784; France: EP0426273, EP0833674, EP0836492, EP0837708, EP0891784, EPO931555; Germany: 69013289.1, 69720637.8, 69724600.0, 69726089.5, 69726683.4, 69731650.5, M9608875.3; Greece: 20030404616, 20040400581; Hong Kong: 1002288, 1002294, 1026249, 1026250, HK1002291, HK1002353; Ireland: EP0836492, EP0891784; Italy: 20471BE2004, 22304BE/04, 34797BE2003, 36769BE2003, 72121; Japan: 1002447, 3473958; Korea: 10-344041, 10-376076, 207012, 428607; Liechtenstein: EP0836492, EP0891784; Luxembourg: EP0836492, EP0891784, EP0836492, EP0891784; New Zealand: 28022, 329316, 329318, 329319, 33087, 333092; Singapore: 47250, 47257, 48670, 51196, 83736, DU2001/267G; Spain: 2206830T3, 2212092T3; Sweden: 61479, EP0833674, EP0836492, EP0837708, EP0891784; Switzerland: EP0836492, EP0891784; Taiwan: 058282, 090525, 092501, 096216, 098653; United Kingdom: 2225065, 2059861, 2312022B, 2312049B, 2312055, 2312234, 2338753, 2338758B. Other U.S. and foreign patents pending.

Table of Contents

Material Specifications	ix
Chapter 1 Introduction	1-1
User Assistance Information.....	1-1
North America	1-1
Outside North America.....	1-1
Overview.....	1-1
Safety Summary.....	1-3
Standards.....	1-3
Labeling Symbol Definitions.....	1-4
Warnings and Cautions	1-6
Definitions	1-6
Warnings.....	1-7
Cautions	1-9
Notes	1-10
Indications for Use.....	1-10
Chapter 2 Description	2-1
Overview.....	2-1
Description of Controls and Indicators	2-2
Front Panel Features	2-2
Pump Module Features	2-6
Rear Panel Features	2-9
Color Reference Guide	2-10

Display Reference Guide	2-10
Main Display Screen.....	2-11
Programming Screens	2-13
Pop-up Windows	2-14
Menus	2-14
Main Display Icons	2-14
Label Location	2-17
Pump Software Features	2-19
PERSONALITY Feature Sets	2-19
Label Library	2-20
Infusion Modes	2-20
Rate-Volume Infusions	2-21
Volume-Time Infusions	2-21
COLLEAGUE GUARDIAN Feature	2-21
Dose Modes	2-24
How Concentration is Determined	2-24
How Doses and Rates are Calculated.....	2-24
Changing a Parameter After All Parameters Have Been Entered ...	2-25
Changing Units of Measure.....	2-25
Primary Delay Start Mode	2-26
Chapter 3 Preparation for Use	3-1
Environmental Conditions	3-1
Setup Instructions	3-1
Initial Installation	3-1
Mounting the Pump on an IV Pole	3-2
Mounting the Pump on a Headboard (Single Channel Pumps Only)	3-2
Changing the Mounting Bracket Orientation (Single Channel Pumps Only)	3-3
Check-out.....	3-3

Chapter 4 Operating Instructions	4-1
<i>Starting Up</i>	4-1
Powering On Using AC Power	4-1
Selecting a Pump PERSONALITY Feature Set	4-5
Viewing PERSONALITY Feature Settings at Power-Up	4-5
Adjusting the Audible Volume	4-6
Adjusting the Display Contrast	4-6
Powering On Using Battery Power	4-6
Full/Partial Battery Charge	4-6
Low Battery Condition	4-7
Depleted Battery Condition	4-7
<i>Operating on Battery Power</i>	4-8
Battery Charge Icon Descriptions	4-8
Battery Charge Alerts and Alarms	4-10
Battery Charge Progress Indicator Alert	4-12
Damaged Battery Alert and Alarm	4-13
<i>Preparing for an Infusion</i>	4-13
Preparing the Primary Infusion Container and Set	4-13
Replacing the Primary Infusion Container (Using the Same Administration Set)	4-15
Recommended Administration Sets	4-15
Loading the Administration Set	4-16
Using the Optional Prime Function	4-18
Overview	4-18
Priming the Administration Set	4-18

<i>Programming an Infusion</i>	4-21
Primary Infusions.....	4-21
Programming a Primary Rate-Volume Infusion.....	4-21
Selecting a Label.....	4-24
Programming a Primary Volume-Time Infusion.....	4-25
Programming a Primary COLLEAGUE GUARDIAN Infusion (Rate-Volume)	4-27
Programming a Primary COLLEAGUE GUARDIAN Infusion (Non-Weight-Based).....	4-31
Programming a Primary COLLEAGUE GUARDIAN Infusion (Weight-Based).....	4-34
Programming a Primary Dose Mode Infusion (Non-Weight Based)	4-39
Programming a Primary Dose Mode Infusion (Weight-Based)	4-43
Secondary Infusions.....	4-48
Setting up a Secondary Infusion	4-49
Programming a Secondary Rate-Volume Infusion	4-50
Programming a Secondary Volume-Time Infusion	4-52
Enabling the Secondary Callback Alert Option.....	4-56
Standby Mode	4-56
Standby Activation (Single Channel Pumps)	4-57
Standby Activation (Triple Channel Pumps).....	4-58
Standby Deactivation	4-60
Starting a Primary Infusion After Exiting Standby	4-60
Starting a Secondary Infusion After Exiting Standby	4-61
Programming a Delay Start Infusion	4-62
Viewing Delay Start Settings Prior to the Start of Infusion	4-64
Exiting Delay Start Mode.....	4-65
Powering On with Delay Start Infusions.....	4-66
<i>While the Infusion is Running</i>	4-67
Managing Volume History	4-67
Changing the Primary Flow Rate During an Infusion	4-68
Changing the Dose During an Infusion	4-69
Changing Volume, Weight or Concentration During an Infusion.....	4-69

Adding or Changing a Label Line During an Infusion	4-71
Viewing COLLEAGUE GUARDIAN Limits During an Infusion	4-71
Changing the Secondary Flow Rate During an Infusion	4-73
Panel Lockout	4-74
Activating/Deactivating Panel Lockout.....	4-74
Auto Lock	4-75
Completing an Infusion	4-75
Stopping a Primary Infusion Before Completion	4-75
Stopping a Secondary Infusion Before Completion	4-76
Infusion Complete (Switch to KVO)	4-77
Unloading the Administration Set	4-78
Automatic Unloading.....	4-78
Using the Manual Tube Release	4-79
Resetting the Manual Tube Release	4-80
Powering Off the Pump	4-81
Options Menu	4-82
Overview.....	4-82
Managing Occlusion Settings	4-83
Auto Restart	4-84
Viewing PERSONALITY Settings	4-85
Using Flow Check Display	4-85
Using the Configuration/Service Function	4-86
Chapter 5 Optional Pump Accessories	5-1
Syringe Adapter	5-1
COLLEAGUE GUARDIAN Configuration Tool	5-2
COLLEAGUE DL2 Event History Download Application	5-2

Chapter 6 Configurable Options.....	6-1
Overview.....	6-1
General Pump Options.....	6-2
COLLEAGUE GUARDIAN Feature Options	6-3
Options Specific to PERSONALITY Feature Sets.....	6-4
Label Library	6-7
Predefined Labels	6-7
Application Labels.....	6-9
Custom Labels	6-10
 Chapter 7 Maintenance and Storage	 7-1
Cleaning.....	7-1
Maintenance.....	7-2
Preventive Maintenance.....	7-2
Battery Care	7-3
Battery Service Life.....	7-4
Optimizing Battery Service Life	7-5
Charging the Batteries	7-5
Disposing of Used Batteries	7-6
Storage	7-6
 Chapter 8 Troubleshooting	 8-1
Alert, Alarm, and Failure Messages	8-1
Restoring a Darkened Screen.....	8-1
Troubleshooting Failures	8-2
Overview.....	8-2
Device Failure.....	8-2
Channel Failures (Single Channel Pumps).....	8-3
Channel Failures (Triple Channel Pump).....	8-5

Troubleshooting Alarms	8-7
Overview.....	8-7
About the Damaged Battery Alarm	8-8
Troubleshooting Air Detected Alarms.....	8-9
Troubleshooting Other Alarms	8-12
Troubleshooting Alerts	8-16
Chapter 9 Technical Specifications	9-1
Pump Specifications	9-1
Interfaces.....	9-4
Configuration Transfer Cable	9-4
COLLEAGUE Communication Cable	9-5
External Monitoring.....	9-5
Recommended Practices	9-5
Volumetric Accuracy of the System.....	9-6
Startup Graph Description	9-7
How Trumpet Curve Graphs are Interpreted	9-8
How Trumpet Curve Graphs are Created	9-8
How Trumpet Curves can be Used.....	9-9
Accuracy Tests.....	9-9
Tested at 1 mL/hr	9-9
Tested at 25 mL/hr	9-11
Electromagnetic Compatibility Statement	9-14
Chapter 10 Warranty and Service Information	10-1
Warranty	10-1
Service Information	10-2
Authorized Service Centers	10-2

Chapter 11 Quick Reference Guide	11-1
User Assistance Information.....	11-1
North America	11-1
Outside North America.....	11-1
Warnings and Cautions.....	11-2
Warnings.....	11-2
Cautions	11-2
Power On and PERSONALITY Feature Set Selection	11-3
Power Off.....	11-4
Loading the Administration Set.....	11-4
Programming a Primary Rate-Volume Infusion.....	11-6
Selecting a Label.....	11-7
Programming a Primary Volume-Time Infusion.....	11-8
Programming a COLLEAGUE GUARDIAN Infusion (Rate-Volume).....	11-8
Programming a COLLEAGUE GUARDIAN Dose Mode Infusion	11-10
Programming a Dose Mode Infusion.....	11-13
Programming a Secondary Rate-Volume Infusion.....	11-14
Programming a Secondary Volume-Time Infusion.....	11-15
Standby Mode	11-15
Unloading the Administration Set	11-17
Automatic Unloading.....	11-17
Using the Manual Tube Release (MTR).....	11-17
Resetting the Manual Tube Release	11-18
Troubleshooting Failures	11-20
Device Failure.....	11-20
Channel Failures	11-20
Troubleshooting Alarms	11-21
Troubleshooting Alerts	11-23
 Index	 Index-1

Material Specifications

The pump contains the plastics and alloys listed below.

Note: No natural latex was used in the manufacture of this pump or its power cord and plug.

- Acrylonitrile Butadiene Styrene (ABS)
- Acetal 25% Glass Fiber (GF) Reinforced
- Acetal + Polytetrafluoroethylene (PTFE)
- Acrylic
- Aluminum A380.0
- 13% GF Nylon
- 30% GF Nylon
- 33% GF Nylon
- 30% GF Reinforced Polybutylene Terephthalate (PBT)
- 30% GF PBT + PTFE
- 40% GF Polyphenylene Sulfide (PPS)
- Nylon
- PBT
- Polycarbonate (PC)
- PC/ABS
- PC/Polyethylene Terephthalate (PET)
- Polyetheretherketone (PEEK)
- PET Glycol (PETG)
- Polyester PBT
- Polyimide
- Polypropylene
- Poron Urethane Foam
- Silicone with silver coated glass beads
- Thermoplastic Synthetic Rubber

Introduction

User Assistance Information

North America

For technical service of the COLLEAGUE pump call
1-800-THE-PUMP

For product usage information or clinical questions, call Baxter
Medication Delivery Product Information Center at 1-800-933-0303.

Outside North America

Visit www.baxter.com/baxter_worldwide.html for contact information
or call your Baxter customer service representative to locate the nearest
service center.

Overview

Note: All information contained in this manual is applicable to the
COLLEAGUE CXE (single channel pump) and COLLEAGUE 3
CXE (triple channel pump) unless otherwise noted.

The COLLEAGUE CXE and COLLEAGUE 3 CXE pump features
include:

- Three independent pump channels for infusions (triple channel
pump only)
- Basic delivery programming
- Micro and Macro rate range

- Adding secondary medications/solutions with configurable Callback option
- Special programming functions for dosing
- Configurable PERSONALITY feature sets
- Uses Baxter standard administration sets equipped with keyed slide clamps. See “Recommended Administration Sets,” 4-15.
- Automatic tube loading with misloading detection
- A label library displaying the medication/solution being administered. There are 64 predefined labels in the library; up to 436 additional custom labels can be programmed if desired.
- The COLLEAGUE GUARDIAN feature, which is a clinical decision support tool that allows the clinician to compare pump programming with facility-defined guidelines at the point of care. If the clinician programs any values outside of the rule sets established by the facility, an out of limits warning occurs. The COLLEAGUE GUARDIAN feature is a configurable option that is available for both rate/volume and dose mode programming.
- Programmable air sensor with detection sensitivity ranging from 25 to 150 microliters
- Programmable downstream occlusion detection settings ranging from 2 psig to 15 psig (103 mmHg to 775 mmHg)
- Automatic restart if downstream occlusions are corrected within 60 seconds after pump detects them
- A flow check graphic displaying downstream in-line resistance to flow
- Compatibility with a variety of source containers
- A panel lockout function that helps minimize the potential for tampering or inadvertent removal of the administration set
- A battery charge level indicator to indicate the battery charge level for transport applications
- A Delay Start feature that allows infusions to be programmed in advance, then started at the programmed start time
- Mounting clamp (single channel pump includes headboard mounting provisions)
- Communications port
- Diagnostic functions

The pump has a flexible graphical interface that can be used to configure the available features. As many as eight custom PERSONALITY feature sets can be created by selecting the operating functions which are needed to meet the needs of an individual care area or for specific therapies. This flexible platform allows the pump to be used for simple infusions and/or therapies requiring complex dose calculations. See “Technical Specifications,” 9-1 for configurable features and default settings.

Although the pump has been designed and manufactured to exacting specifications, it is not intended to replace trained personnel in the monitoring of infusions.

Safety Summary

Standards

In accordance with UL 60601-1 and CAN/CSA C22.2 No. 601.1, this pump is classified as:

- Class 1
- Type CF
- Drip-proof (IPX1)
- Not suitable for use with flammable anesthetic mixtures with air, oxygen or nitrous oxide
- Continuous operation

This manual has been developed with consideration to the requirements in the International Standard, IEC 60601-2-24: 1998, Medical Electrical Equipment — Part 2-24: Particular Requirements for Safety of Infusion Pumps and Controllers. Data presented in the Technical Specifications reflect specific test conditions defined in this standard. Other external factors such as varying back pressure, temperature, head height, set usage, fluid restrictions, solution viscosity, or combinations of these factors, may result in deviations from the performance data enclosed.

When disposing of this device, its batteries, or the administration sets designed for use with the device, follow local regulations and guidelines.

Note: **Outside the U.S.:** read document DIN VDE 0753-5, *Rules of application for parallel infusion; conceivable methods for use*, when performing parallel infusions.

Labeling Symbol Definitions

■ Labeling symbol definitions (device and packaging):

IPX1

Drip-proof equipment: enclosed equipment protected against dripping fluids in accordance with IEC 60529.



Alternating current or equipment intended to be connected to an alternating current (AC) source.

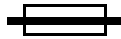

Fuse.



Attention, consult accompanying documents.



Type CF equipment in accordance with UL 60601-1. The Type CF Applied Part symbol indicates the level of electric shock protection for the patient contacting parts such as the IV set. UL/IEC/EN 60601-1 defines CF as providing greater protection than Type B or Type BF.



Manufacturer.



Recyclable, dispose of properly.



For products where this mark is present, the device is classified by Underwriters Laboratories Inc. with respect to electric shock, fire, and mechanical hazards only in accordance with UL 60601-1 and CAN/CSA C22.2 No. 601.1.



Brazil certification to:

- INMETRO - National Institute of Metrology, Standardization and Industrial Quality.
- USP-IEE - University of São Paulo Institute of Electrotechnics and Energy.



Catalog number.

SN

Serial number.



Symbol (WEEE 2002/96/EC)

For product disposal, ensure the following:

- Do not dispose of this product as unsorted municipal waste.
- Collect this product separately.
- Use collection and return systems available to you.

Bar below bin: Product distributed after August 13, 2005.

For more information on return, recovery or recycling of this product, please contact your local Baxter representative.



For product disposal, ensure the following:

- Do not dispose of this product as unsorted municipal waste.
- Collect this product separately.
- Use collection and return systems available to you.
- **Battery must be recycled.**

Bar below bin: Product distributed after August 13, 2005.

Battery: **Nonspillable** lead acid sealed battery.

For more information on return, recovery or recycling of this product, please contact your local Baxter representative.

Fragile; handle with care.



Keep dry.



Operating temperature limits.



Storage temperature limits.

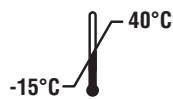

Transport temperature limits.

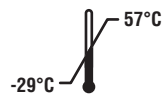

Transport humidity limits.



Transport atmospheric pressure limits.

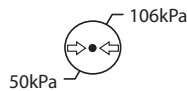

Carton stacking limit (single channel pump).



Carton stacking limit (triple channel pump).



- Labeling abbreviations:

COMM. PORT Communications Port
VOL. Volume
CONT. Contrast

- Serial Number Format:

Year of Manufacture
(15 = 2005)

Month of
Manufacture

SN 15040362DS

Sequential
Number

Single Channel COLLEAGUE
CXE Pump

Year of Manufacture
(15 = 2005)

Month of
Manufacture

SN 15060362US

Sequential
Number

Triple Channel COLLEAGUE 3
CXE Pump

Examples:

15061234US manufactured June 2005
17122456DS manufactured December 2007

Warnings and Cautions

General Warnings and Cautions are included here. Additional Warnings and Cautions appear throughout the manual.

Definitions

Warning messages indicate a possible hazard which, if not avoided, could result in severe personal injury or death.

Caution messages indicate a problem or unsafe practice which, if not avoided, could result in minor or moderate personal injury, product or property damage.

Note messages provide supplemental information to the accompanying text.

Warnings

General Warnings:

! WARNING !

The COLLEAGUE 3 CXE pump is intended for use in delivering multiple infusions to a single patient. Never use the pump to deliver infusions to more than one patient simultaneously.

! WARNING !

Do not use this pump in Linear Accelerator Radiation Therapy suites or Magnetic Resonance Imaging Suites.

! WARNING !

Do not use the COLLEAGUE pump in hyperbaric chambers.

! WARNING !

Do not use the COLLEAGUE pump with Extracorporeal Membrane Oxygenation (ECMO) systems.

! WARNING !

Epidural administration of drugs other than those indicated for epidural use could result in serious injury to the patient.

- Epidural administration of anesthetics is limited to short term infusion (not to exceed 96 hours) with indwelling catheters specifically indicated for short term anesthetic epidural drug delivery.
- Epidural administration of analgesics is limited to use with indwelling catheters specifically indicated for either short term or long term analgesic epidural drug delivery.
- To prevent infusion of drugs not indicated for epidural use, do not use administration sets incorporating injection sites during epidural delivery.
- Clearly distinguish pumps used for epidural drug delivery from pumps used for other routes of administration.

! WARNING !

This device should be repaired only by Baxter authorized service personnel or Baxter-trained hospital biomedical engineering personnel, using only Baxter recommended parts. There are risks associated with using anything other than Baxter recommended parts. Baxter will assume no responsibility for incidents which may occur if the product was not repaired in accordance with procedures authorized by Baxter.

Procedural Warnings:

! WARNING !

If the pump has been dropped or appears to be damaged, it should be taken out of service and inspected by Baxter-trained, qualified personnel only.

! WARNING !

Clinicians are advised to verify the proper route of delivery and that the infusion site is patent. When using this pump, periodic patient monitoring must be performed to ensure that the infusion is proceeding as expected. The pump is capable of developing positive fluid pressures to overcome widely varying resistances to flow such as resistance imposed by small-gauge catheters, filters, or intra-arterial infusions. Although the pump is designed to stop fluid flow when an alarm occurs, it is neither designed nor intended to detect infiltrations and will not alarm under infiltration conditions.

! WARNING !

Use only Baxter standard administration sets equipped with keyed slide clamps that are labeled as being COLLEAGUE pump compatible or denoted with an “s” in the product code. If you have questions about administration set compatibility, contact the Baxter Product Information Center at the number shown on the administration set labeling. Using anything other than the recommended administration sets with this pump will result in operation that is not within the constraints and parameters of the device.

Severe injury or death may result from using sets other than those approved by Baxter Healthcare Corporation for use with COLLEAGUE pumps. Always read and follow the instructions in the Operator’s Manual and those accompanying the set and source container.

! WARNING !

Use only CONTINU-FLO standard administration sets equipped with keyed slide clamps and labeled as COLLEAGUE pump compatible or denoted with an “s” in the product code as the primary fluid line when administering a secondary medication/solution. See “Recommended Administration Sets,” 4-15. Carefully follow the directions on the primary and secondary administration set labels.

When using the secondary infusion feature ensure:

- the medication/solution in the secondary source container is compatible with the medication/solution in the primary source container.
- the secondary administration set is connected to the appropriate injection site on the CONTINU-FLO administration set.
- the interruption of the primary infusion is clinically appropriate for the duration of the secondary infusion.
- the infusion runs from a secondary source container and not from a primary container.

! WARNING !

Pulling or tugging on the administration set tubing between the pump channel and the patient may cause false Air Detected alarms, which will cause the pump to stop infusing. In order to reduce the potential for this situation to occur:

- First, select an appropriate length administration set.
- Before loading the set into the pump, position the keyed slide clamp at an appropriate location along the tube segment to ensure that there is adequate length of tubing between the patient and the pump to reduce tugging on the set.
- Lastly, ensure there is sufficient slack in the tubing between the distal end of the tubing channel and the patient to prevent tube tugging during activities such as moving the patient from one bed to another, or transportation of the patient from one facility location to another.

In order to avoid false alarms, the pump should never be placed on the bed alongside the patient.

! WARNING !

The pump may not detect an upstream occlusion if one or more of the following conditions exist:

- All air removed from the source container
- Incomplete insertion of the spike into the source container
- Improper venting of a rigid (glass bottle) or semi-rigid (plastic) container, including BURETROL sets

If using rigid non-vented containers, refer to the appropriate administration set instructions to determine the correct venting procedure.

- The air vent above the burette chamber is not open

To help prevent upstream occlusions that may not be detected by the pump:

- Do not use a source container that has had all air removed.
- When using a BURETROL set, do not invert BURETROL and squeeze fluid into the primary container, which may wet out the vent filter and obstruct airflow.

! WARNING !

Do not allow fluid to enter the tubing channel or load wet tubing into the pump. Contact your Baxter Service Center for assistance immediately if fluid enters the tubing channel. The tubing channel should be cleaned as soon as possible by Baxter-trained, qualified personnel to minimize potential difficulties caused by fluid pooling and drying on the mechanism. Fluid in the tubing channel can also cause false Air In Line alarms. See “Authorized Service Centers,” 10-2.

! WARNING !

There may be periods of no flow for flow rates less than or equal to 1mL/hr.

! WARNING !

Do not enter a Volume to be infused greater than the amount of fluid available in the container.

! WARNING !

COLLEAGUE pumps do not support same-bag loading dose or bolus as it may lead to an over-infusion, under-infusion, or interruption of therapy.

Cautions

General Cautions:

CAUTION

In the U.S., use of device is restricted by Federal Law (USA) to sale or use by, on the order of, or under the supervision of a physician or other licensed healthcare professional.

CAUTION

Follow the cleaning schedule and methods defined under “Cleaning,” 7-1 to ensure proper maintenance of the device.

Notes

Note: Baxter requests that parties acquiring this device:

- Promptly report the receipt of this device to the manufacturer;
- Report the device's purchases, receipt in trade, return after sale, loss, destruction, or retirement.
- If this is an initial purchase from the manufacturer, you may return a signed copy of the packing list to the manufacturer in order to comply with these requirements. Call 1-800-THE-PUMP or Baxter's local sales office for additional information.

Indications for Use

The COLLEAGUE CXE and COLLEAGUE 3 CXE Volumetric Infusion Pumps are capable of delivering medications, solutions, parenteral nutrition, lipids, blood and blood components.

The COLLEAGUE CXE and COLLEAGUE 3 CXE pumps are capable of infusing from semi-rigid containers, rigid containers, flexible IV bags, and vented syringes.

The COLLEAGUE CXE and COLLEAGUE 3 CXE pumps are designed to deliver infusion therapies via clinically acceptable routes of administration, including intravenous, intra-arterial, epidural, and subcutaneous routes.

The COLLEAGUE CXE and COLLEAGUE 3 CXE pumps are intended for use in a wide variety of patient care environments for adult, pediatric, and neonatal patients. The COLLEAGUE CXE and COLLEAGUE 3 CXE pumps facilitate the delivery of routine and critical infusion therapies via continuous and intermittent delivery using primary and secondary infusion modes.

The COLLEAGUE CXE and COLLEAGUE 3 CXE pumps can be used in the following care areas:

- General Floor of the Hospital
- Critical/Intensive Care
- Neonatal Intensive Care
- Pediatric Care
- Labor/Delivery/Postpartum
- Operating Room/Anesthesia
- Post Anesthesia/Recovery
- Cardiac Catheterization Lab
- Emergency Room
- Ground Ambulance
- Hospice Facility
- Outpatient/Subacute Facilities
- Nursing Facilities
- Long Term Care/Rehabilitation Facilities
- Diagnostic Nuclear Medicine
- Oncology Floor
- Burn Unit/Trauma

Note: The COLLEAGUE CXE and COLLEAGUE 3 CXE pumps have not been evaluated for use in care areas other than those listed above.

Description

Overview

This chapter describes the controls, indicators, and displays on the pump, and provides a brief functional description of the pump's features and infusion modes. The following information is provided in this chapter:

- “Description of Controls and Indicators” on page 2-2
- “Display Reference Guide” on page 2-10
- “Label Location” on page 2-17
- “Pump Software Features” on page 2-19
- “Infusion Modes” on page 2-20

Description of Controls and Indicators

Front Panel Features

Figure 2-1 is the front view of the single channel pump.

MAIN BODY
See Table 2-1

MAIN DISPLAY

PUMP MODULE
See Table 2-2

PUMP MODULE DISPLAY

SLOT FOR KEYED SLIDE CLAMP

FLUID FLOW DIRECTION LABEL

STATUS LEDS

TUBING CHANNEL

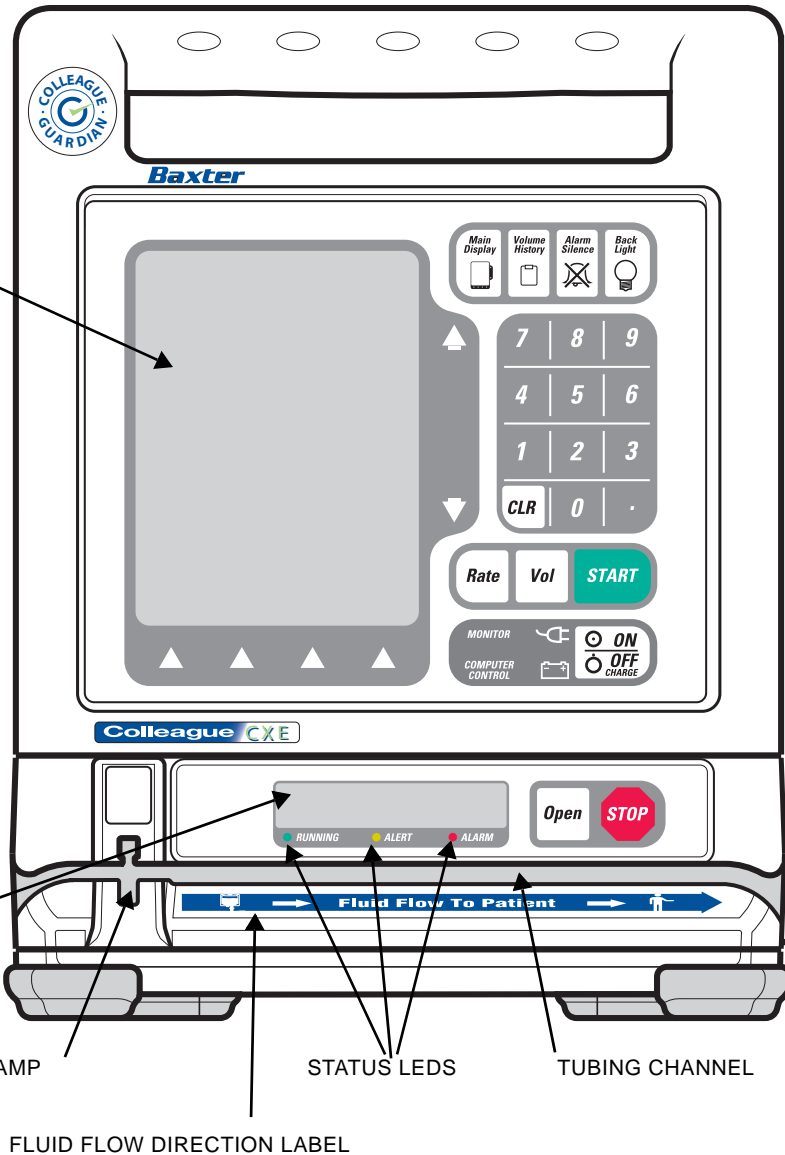

Figure 2-1 Front View, Single Channel Pump

Figure 2-2 is the front view of the triple channel pump. Table 2-1 describes the controls and indicators on the main body of the pump.

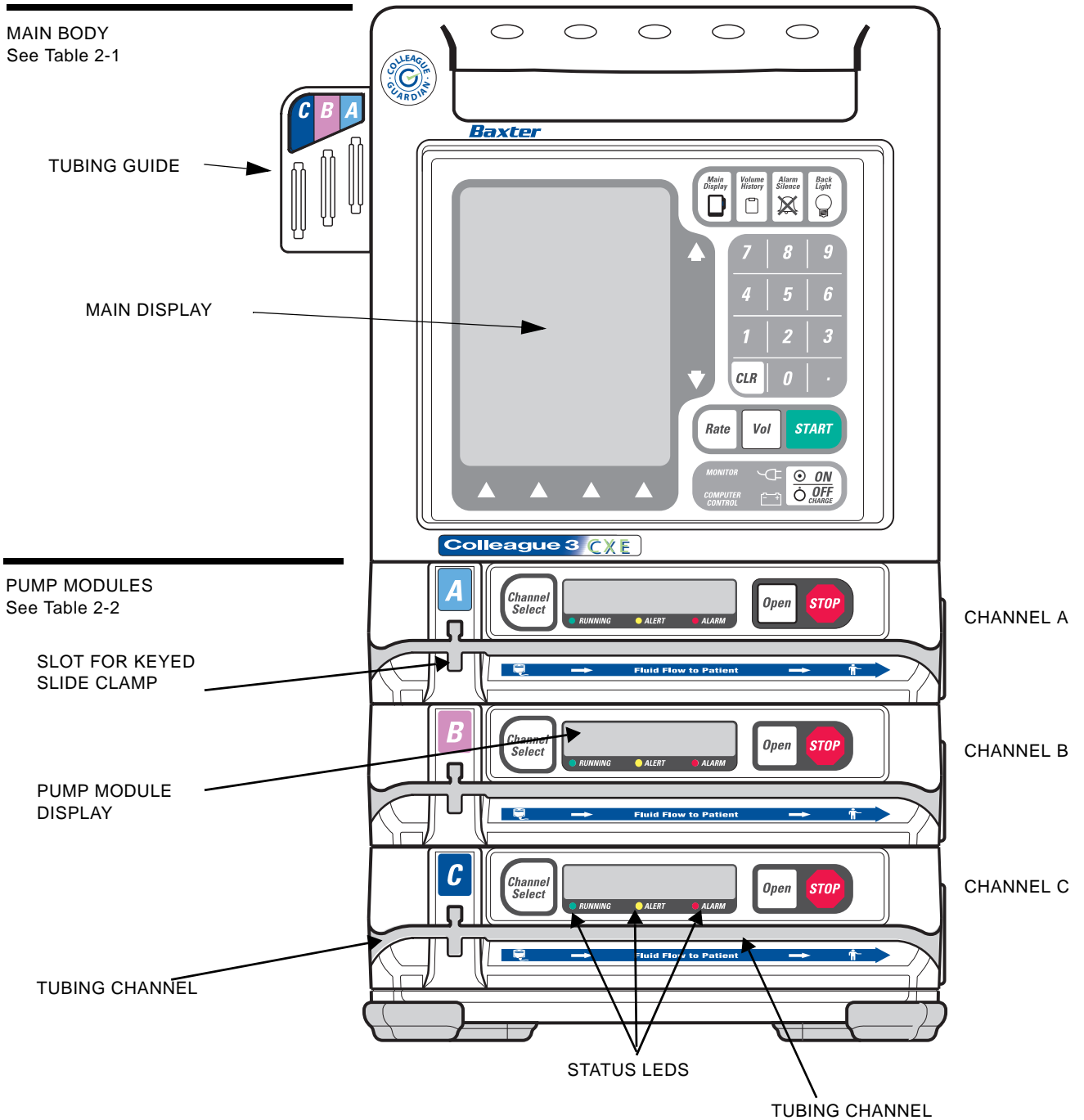

Figure 2-2 Front View, Triple Channel Pump

Table 2-1 Main Body Controls and Indicators









Item	Description
Function Keys	
	<p>This key accesses the Main Display screen from all other operating screens, except screens with pop-up windows or passcode service functions.</p>
	<p>This key accesses the Volume History screen, allowing the user to view a history of volume delivered. For triple channel pumps, the volume history screen presents information for all three channels.</p>
	<p>This key silences alarms and alerts for two minutes.</p>
	<p>This key turns the back lights for the main display and the pump module display(s) on and off.</p> <p>When the display goes dark while the pump is running on battery power, pressing this key will re-illuminate the main display and turn on the pump module display(s) for 60 seconds.</p>
Action Keys	
	<p>This key selects the Rate field.</p>
	<p>This key selects the Vol (Volume to be infused) field.</p>
	<p>This key initiates the infusion from any programming screen if all the required programming values have been entered and confirmed.</p>
	<p>This key powers the pump on or off. If the pump is on, pressing this key once causes the pump to display the Power Off pop-up, which requests confirmation that the user intends to turn the pump off.</p>

Table 2-1 Main Body Controls and Indicators — continued







Item	Description
Numeric Keypad	
	<p>The numeric keys and decimal point key are used to enter programming values.</p>
	<p>The CLR (Clear) key clears the highlighted value from the display. Additionally:</p> <ul style="list-style-type: none"> • pressing the CLR key a second time without moving to another field restores ONLY the last value saved, • if a value is cleared and then another field is highlighted, the cleared value cannot be restored, and • if a value is cleared and then a new value is entered, pressing CLR will clear the new value. Pressing CLR again (without moving off the field) will restore the original value (not the new value). <p>The CLR key can also be used to clear a label if the label field is highlighted and the infusion is stopped.</p>
Icons	
	<p>This green icon is lit whenever the pump is plugged into AC power. Illumination of this icon also indicates the battery is being charged.</p>
	<p>This yellow icon is lit only when the pump is operating on battery power.</p>
<p>MONITOR</p>	<p>For Baxter diagnostic purposes only.</p>
<p>COMPUTER CONTROL</p>	<p>FOR FUTURE USE.</p>
	<p>Triple channel pumps only. The color-coded tubing guide on the left side of triple channel pumps assists the clinician in identifying lines during a multi-channel infusion. The tubing for each channel should be placed in the corresponding tubing guide slot (A, B, C).</p>

Table 2-1 Main Body Controls and Indicators — continued

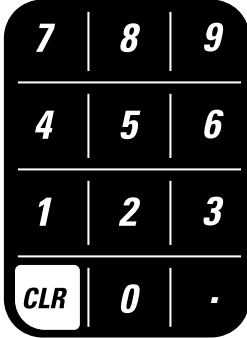
Item	Description
	<p>The pump's Main Display is capable of displaying 10 different colors and includes information for all three channels of a triple channel pump.</p> <p>Note: For optimum viewability, view the display from a position directly in front of the screen.</p>

Pump Module Features

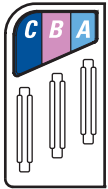
The Pump Module(s) are located below the Main Body. Triple channel pumps have three pump modules. See Figure 2-1 and Figure 2-2 for illustrations of the pump modules. The pump module controls and indicators are described in Table 2-2.

Table 2-2 Pump Module Controls and Indicators



Message Display	Description
Pump Module Display	
	<p>Note: If the pump is running on battery power, the pump module display is blank to conserve battery power.</p> <p>During infusions, the eight-character display on each channel shows one of the following four message options:</p> <ul style="list-style-type: none"> • Rate • Time Remaining • Volume Infused • Label <p>The message displayed depends upon the specific options selected by the care site.</p>
	<p>Specific operations, such as tube loading, are also indicated on the pump module display.</p>
	<p>The pump module display also provides brief alarm and alert messages.</p>

Table 2-2 Pump Module Controls and Indicators — continued











Key	Description
	<p>Triple channel pumps only.</p> <ul style="list-style-type: none"> When pressed once, this key selects or deselects a particular pump channel for use. The LED on the key lights and the selected channel’s programming screen appears on the Main Display. Pressing this key when the channel is selected (LED is on), with no alerts or alarms present and the channel stopped, opens the Standby pop-up for the selected channel, allowing the user to place the channel in Standby. When the pump channel is in Standby, pressing this key takes the channel off Standby and displays the channel’s programming screen.
	<ul style="list-style-type: none"> When there is no administration set in the pump, pressing this key opens the loading mechanism so that the administration set can be loaded. When there is an administration set in the pump, pressing this key opens the loading mechanism so that the administration set can be removed.
	<p>When the pump channel is running, pressing the STOP key for that channel stops the infusion.</p>
Fluid Flow Symbol	Description
	
	<p>This fluid container symbol located below the left side of the tubing channel indicates the upstream side of the pump. When loading the administration set, always ensure that the tubing from the container enters the left side of the pump.</p>
	<p>This patient symbol below the right side of the tubing channel indicates the downstream side of the pump. When loading the administration set, always ensure that the tubing from the pump to the patient exits right side of the pump.</p>
	<p>These arrows indicate the direction of fluid flow while the pump is running.</p>
LEDs	Description
	<p>RUNNING LED This green LED remains on continuously during an infusion.</p>

Table 2-2 Pump Module Controls and Indicators — continued

	<p>ALERT LED</p> <p>This yellow LED remains on continuously during an alert condition, if there are no active alarms.</p>
	<p>ALARM LED</p> <p>This red LED flashes on and off during an alarm condition and remains on continuously during a failure condition.</p>
	<p>CHANNEL SELECT LED</p> <p>Triple channel pumps only. This LED is lit when the associated pump channel is selected.</p>

Rear Panel Features

See Figure 2-3 for the rear view of a triple channel pump. Table 2-3 describes the rear panel features.

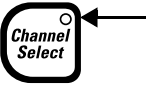
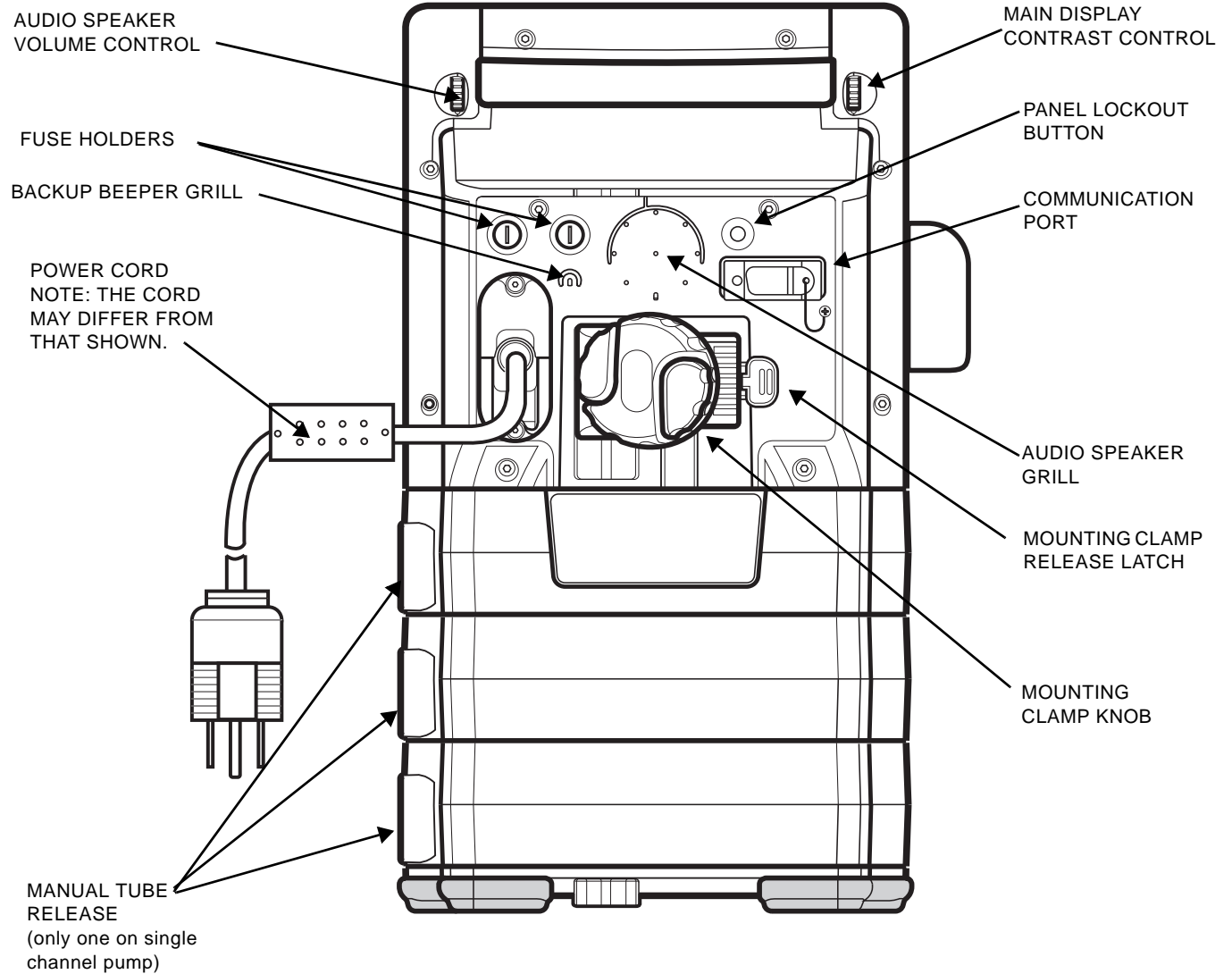

Figure 2-3 Rear View, Triple Channel Pump

Table 2-3 Rear Panel Features

Item	Description
Communication port	An RS232 interface enables optional communication functions. For service use only.
Fuse holders	The pump's fuses are located inside.
Volume and Contrast Controls	Thumbwheels for increasing and decreasing the audio volume and display contrast settings.

Table 2-3 Rear Panel Features — continued

Item	Description
Audio speaker and beeper	Generate alert and alarm tones.
Mounting clamp and knob	Secures the pump to a pole.
Manual tube release	Flip-out knob for manual tube unloading.
PANEL LOCKOUT button	The Panel Lockout button disables all the front panel keys except the Main Display , Volume History , Channel Select (for triple channel pumps only), and Back Light keys, and the Options , Primary , and Secondary soft keys for viewing.

Color Reference Guide

Table 2-4 describes the meaning of the colors used on the device and displays.

Table 2-4 Pump and Display Colors

Color	Description
Yellow	Yellow is used to call attention to a condition. Infusion program information is yellow. Yellow is used in the display status line to indicate an alert condition. The ALERT LED on the pump head module is yellow.
Red	Red is used to indicate a serious condition or stop. Red is used in the display status line to indicate an alarm or failure condition. The red stop sign icon indicates that an infusion is stopped. The ALARM LED and the STOP key on the pump head module are red.
Green	Green is used to indicate normal operation or start. The green drop icon indicates that an infusion is running. The RUNNING LED on the pump head module and the START key on the pump are green.
White	White is used for all basic information on the programming and main display screens, and as a background color for the prompt line and some pop-ups. Also used for the Lock icon and the Flow Check icon.
Dark blue	Dark blue is used as the background color for all programming and main display screens.
Light blue	Light blue is used for the secondary icon.
Black	Black text is used on a yellow background to describe alert conditions.

Display Reference Guide

The Main Display provides two types of screens: the main display screen and programming screens.

Main Display Screen

The main display screen provides information about the current or most recent infusion. Information which may appear on main display screens is described in the following table. Examples of main display screens are shown in and described in Table 2-5.

Table 2-5 Main Display Screen Areas

Area	Function
Battery charge icon/status	A battery charge icon with the estimated battery time displayed in hours and minutes.
Status line	This highlighted area at the top of the display shows alert, alarm, and failure messages. For triple channel pumps, it also identifies the channel to which these conditions apply (A, B, or C). Alert messages appear against a yellow background and alarm or failure messages appear against a red background.
PERSONALITY feature set	The name of the currently selected PERSONALITY feature set is displayed near the top right corner of the display.
Operating state icons	Animated green drop: indicates infusion is running Red stop sign: indicates infusion is stopped. Light blue IV container: indicates that the current infusion is a secondary. Yellow mortar and pestle: indicates that the current infusion is using a label for which COLLEAGUE GUARDIAN feature limits have been configured. Stopwatch: indicates a Delay Start infusion has been programmed.
Infusion parameters	The programmed values for the current or most recent infusion, including rate, time remaining, and volume remaining.
Dose mode identifier	If the current infusion was programmed using a dose mode, the mode is displayed below the program values line.
Prompt Line	The single line of highlighted type just below the body provides prompts for user action.
Pop-up Window	This message box is used to provide additional information that may or may not require user response.
Label (Optional)	A label identifying the current infusion, if configured and selected, is displayed just below the infusion parameters. If the label has been configured with limits using the COLLEAGUE GUARDIAN feature, then the mortar and pestle icon is also displayed on the screen.
↑↓ (Up and Down) Arrow Keys	These keys are used to select programming fields or to perform actions.
Soft Keys	The four keys located below the display screen are referred to as soft keys.
Soft Key Identifiers	Only the key identifiers applicable to the current activity are displayed above the soft keys.

Single Channel Pump

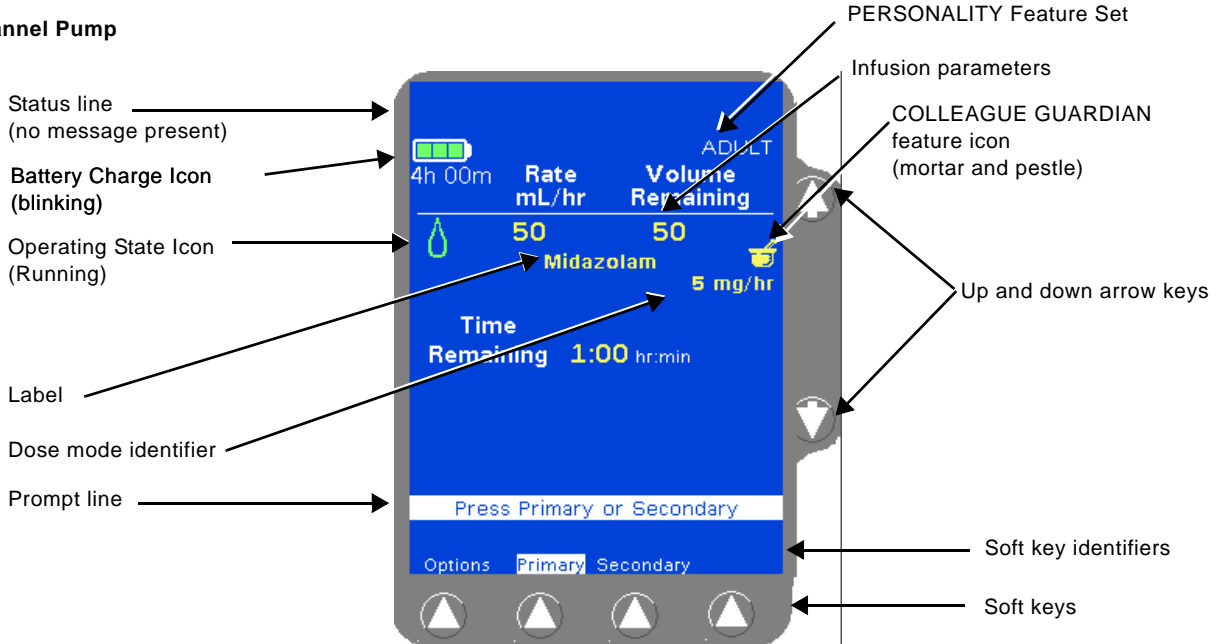

Triple Channel Pump

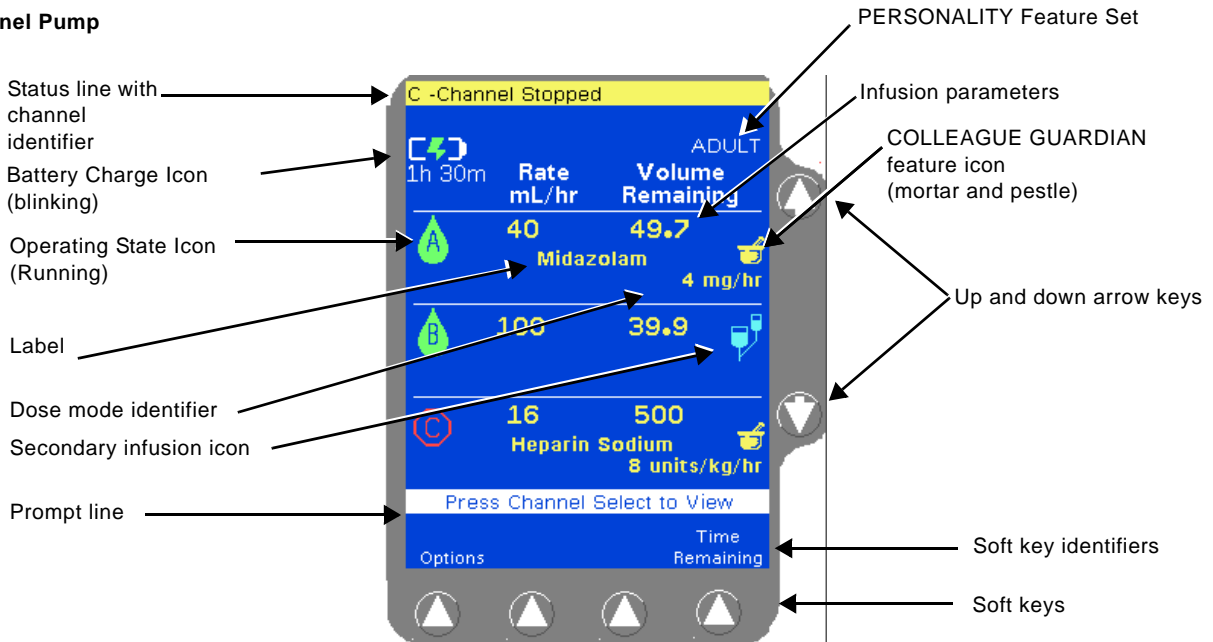
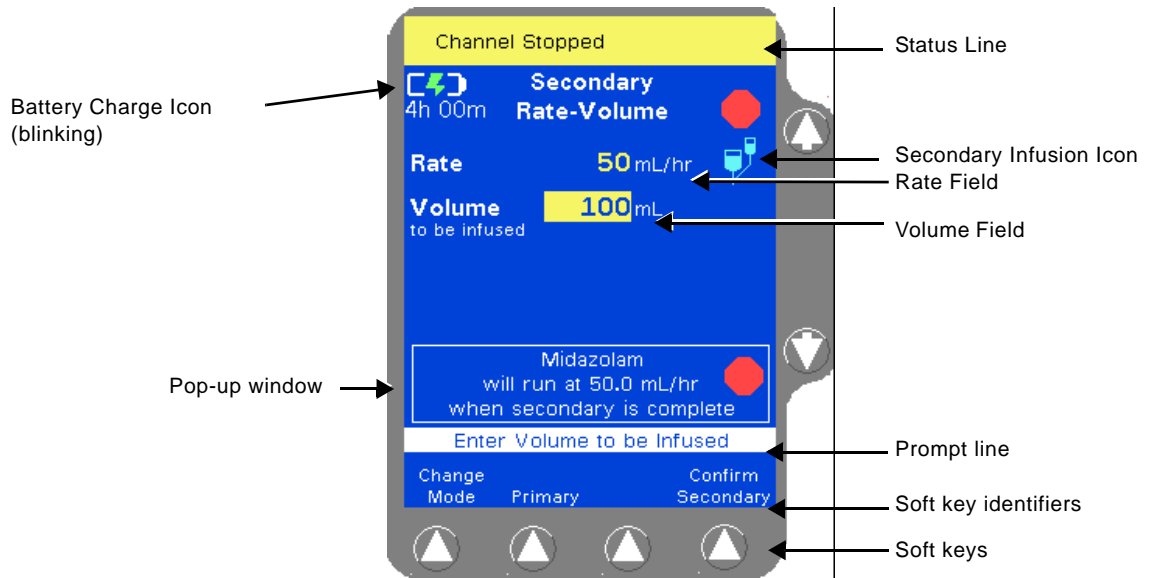

Figure 2-4 Main Display Screen Information—Examples

Programming Screens

Programming screens have fields where infusion program values are entered. The programming screens for each programming mode are different because each mode requires that different information be programmed. Programming screen examples are shown in Figure 2-5.

Single Channel Pump



Triple Channel Pump

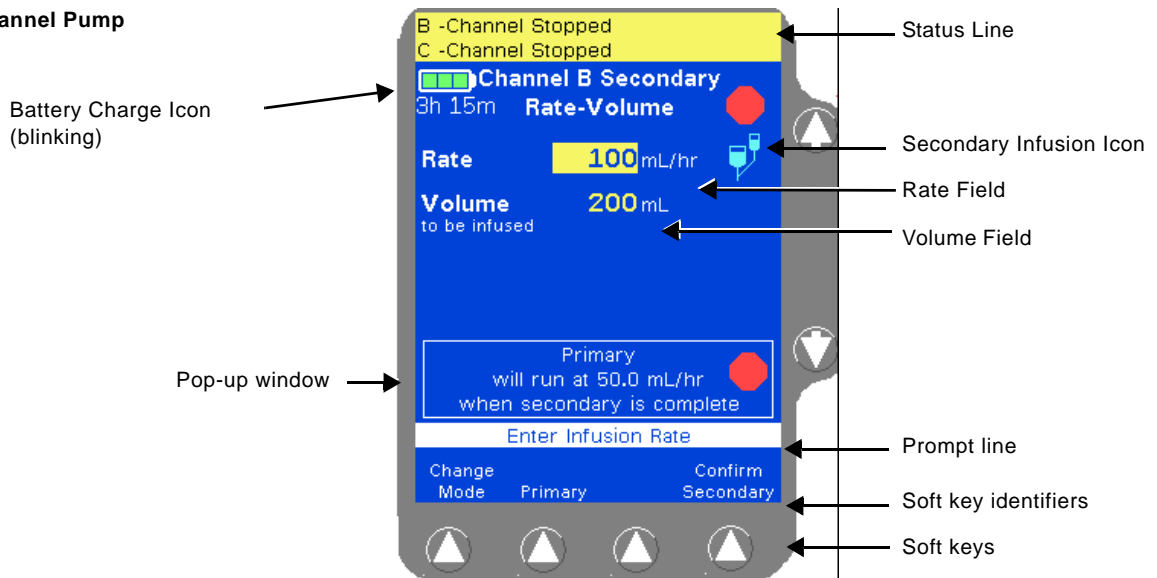

Figure 2-5 Programming Screen Information — Examples

Pop-up Windows

Pop-up windows are message boxes that appear on top of the usual screen display. Pop-ups may require user response in order to clear them from the display.

Menus

In some situations, a menu containing additional selections is provided (Figure 2-6). To select a menu item, use the $\uparrow\downarrow$ keys to highlight the desired selection, then press the **Select** soft key.

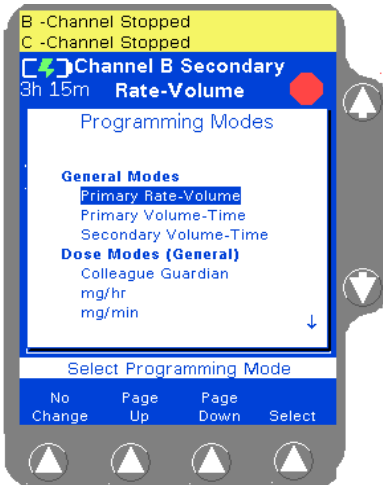

Figure 2-6 Menu Example

Main Display Icons

Table 2-6 describes the icons that appear on the Main Display.

Table 2-6 Main Display Icons





Icon	Description
	This icon indicates that air has been detected by the air sensor.
	This icon indicates that air has exited from the air sensor area and fluid is now detected.
	The battery charge icon is displayed at all times in the upper left part of the screen. The number of filled areas in the battery charge icon is an approximate indication of the battery charge level. When the battery time remaining is 80 to 100%, the icon contains three green bars as shown at left.
	As the battery charge level decreases, the battery charge icon changes. When the battery time remaining is 60 to 80%, the icon contains two green bars as shown at left.

Table 2-6 Main Display Icons — continued









Icon	Description
	As the battery charge level continues to decrease, the battery charge icon continues to change. When the battery time remaining is 20 to 60%, the icon contains two yellow bars as shown at left.
	When the battery time remaining is less than 20%, the battery charge icon contains one red bar as shown at left.
	When the battery time remaining is only 5 minutes, the battery charge icon appears as an empty outline as shown at left. The icon will remain an empty outline until the battery is depleted and pump shuts itself off.
	<p>If the pump's batteries need replacement when the pump is first powered on, or during operation without an infusion running, a Damaged Battery! Service Now alarm occurs and this icon flashes on the Power On screen. The pump cannot be used. Send the pump to service.</p> <p>If the pump's batteries need replacement while an infusion is running, a Damaged Battery! Service Now alert occurs and this icon flashes instead of the battery charge icon. Ensure the pump is plugged into AC power. Do not use the pump for transport. Have the pump serviced as soon as possible so the batteries can be replaced.</p>
	When the pump is plugged in, the battery charge icon alternates with the charging icon shown at left.
	When the pump is unplugged and operating on battery power, the battery charge icon alternates with the Plug In icon shown at left, and the approximate battery operating time is displayed below the icon. The pump should be plugged in whenever possible to maintain battery charge.
	A drop icon is displayed for each channel that is running, and beside the FLUID and AIR icons when the pump is used to purge air from the tubing following an Air In Line alarm.
	The flow check icon indicates approximate level of downstream occlusion. The greater the resistance to fluid flow, the greater the number of solid arrows displayed.
	This icon indicates the screen is displaying secondary infusion information for a channel.
	This icon is displayed on the Programming screen when a pump channel is stopped.
	This icon is displayed on the Main Display screen when a pump channel is stopped. The appropriate channel letter is displayed inside of the stop symbol (A, B, or C).
	When the keypad is locked, the Lock icon is displayed between the second and third soft keys. The following keys remain available when the keypad is locked so that infusion status information can be viewed: Main Display, Back Light, Volume History, Primary, Secondary and Options.

Table 2-6 Main Display Icons — continued

Icon	Description
	<p>This icon indicates a Delay Start infusion. It is displayed on the primary programming screen when programming a delay start infusion for a channel, and on the main display when a programmed delay start infusion is pending for a channel.</p>
	<p>Mortar and pestle icon indicates that the programmed infusion is using a label for which the COLLEAGUE GUARDIAN feature has been configured. Icon appears on the programming screen when a COLLEAGUE GUARDIAN feature label has been selected, and on the main display to the right of each channel running an infusion utilizing a COLLEAGUE GUARDIAN label.</p>
  	<p>Yellow Triangle next to a label in the COLLEAGUE GUARDIAN label list indicates that the label allows non-standard concentrations to be programmed by the clinician.</p> <p>White triangle next to a field on the programming screen for a COLLEAGUE GUARDIAN infusion indicates that the clinician has changed the default value.</p> <p>Triangle next to the label while the infusion is running indicates that the clinician has programmed the infusion using a non-standard concentration.</p>
	<p>When a list contains more information than can be displayed on a single screen, an arrow is displayed in the lower right and/or the upper right corner. Use the Page Up and Page Down soft keys to page through the list.</p>

Label Location

The pump's labels provide additional information about the pump. Figure 2-7 shows the location of the pump's labels for single channel pumps. Figure 2-8 shows the location of the pump's labels for triple channel pumps. If any labels are missing or damaged, contact your local Baxter Service Center for replacement information.

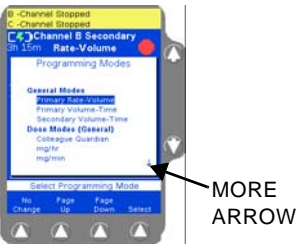
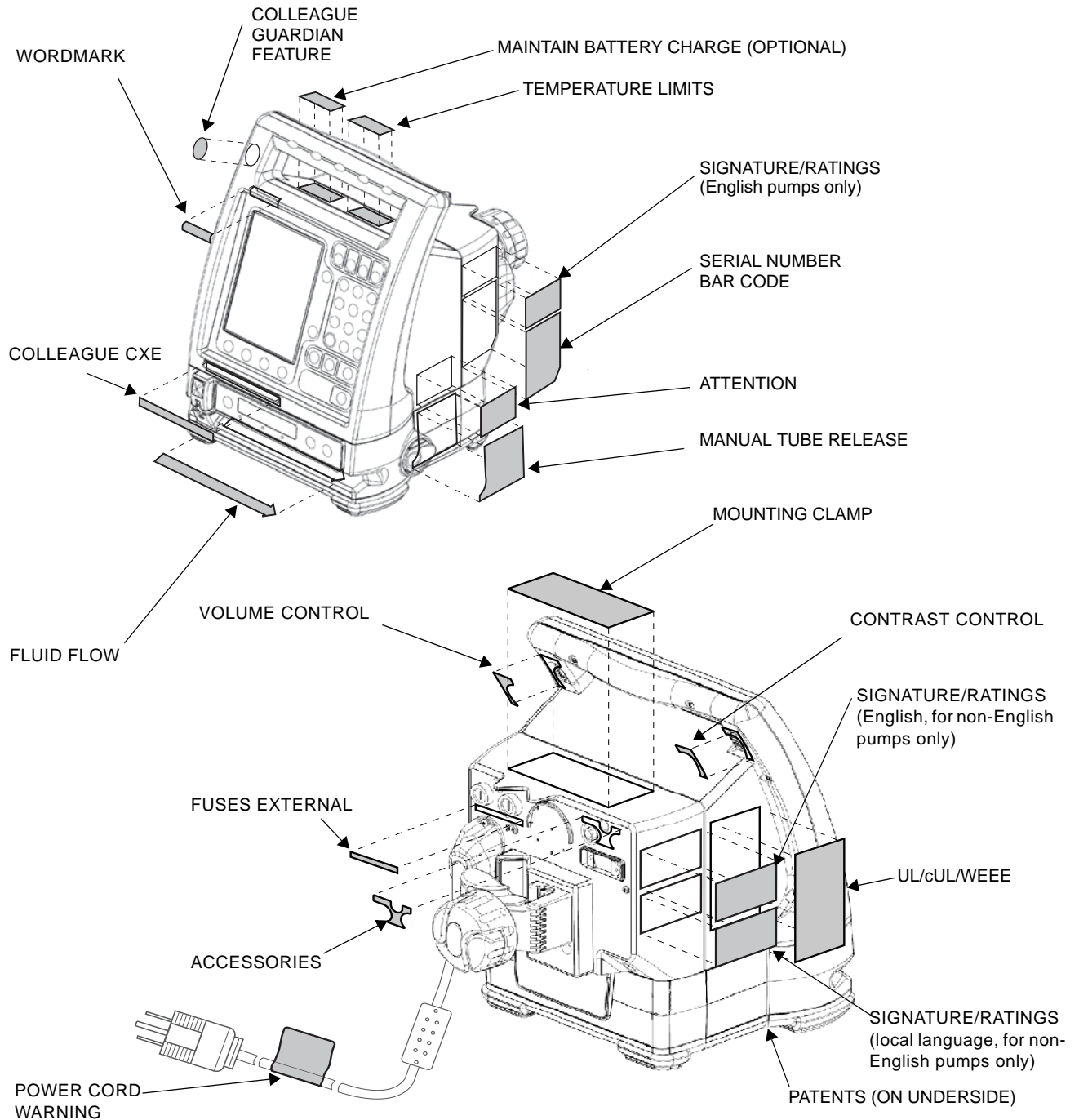

Figure 2-7 Location of Pump Labeling, Single Channel Pump

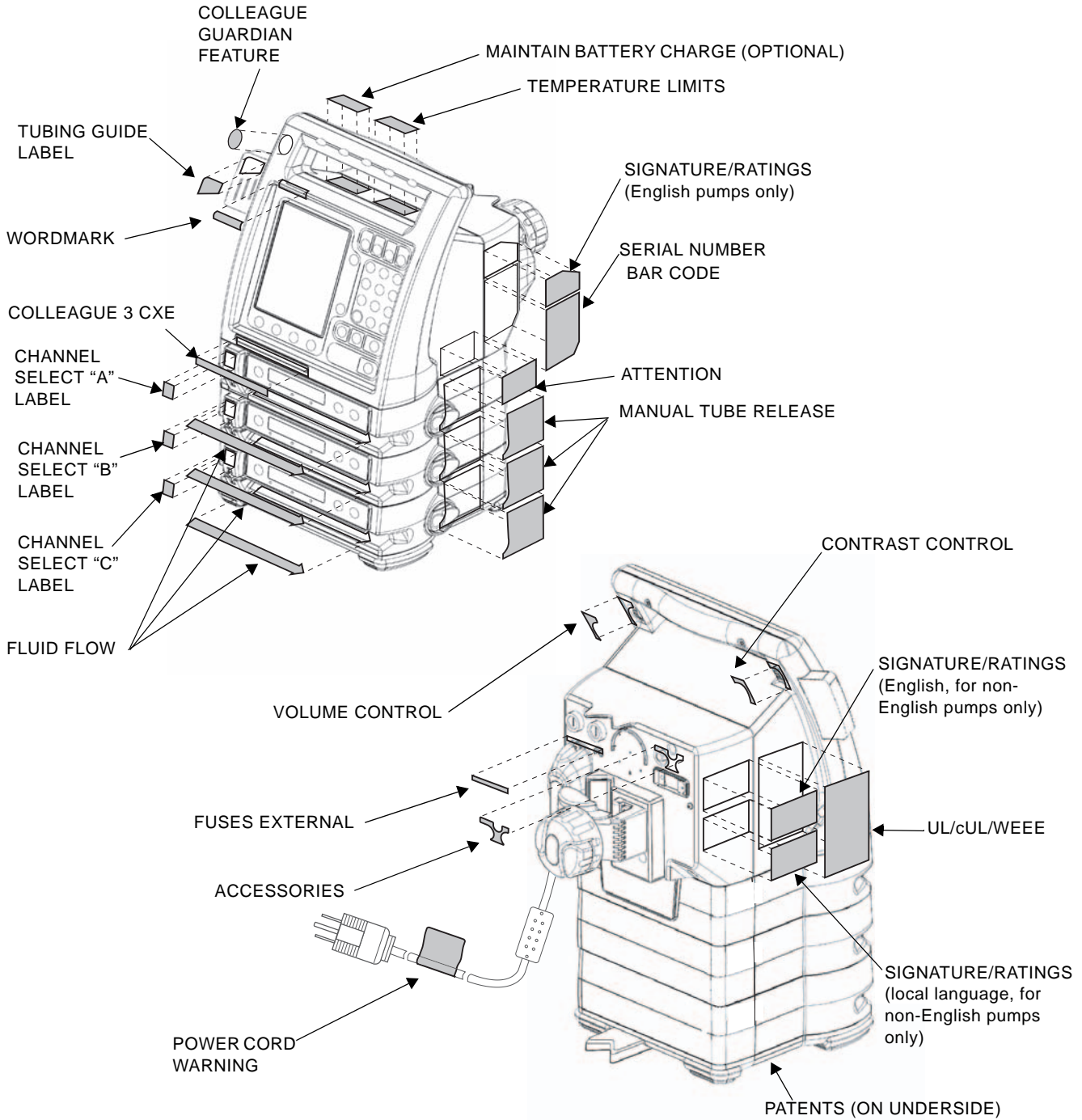

Figure 2-8 Location of Pump Labeling, Triple Channel Pump

Pump Software Features

In addition to basic infusion delivery capabilities, the pump has the following features that help to enhance versatility and to help ensure accurate infusion programming.

PERSONALITY Feature Sets

The pump provides the capability for a facility to create up to eight different custom PERSONALITY feature sets, programmed with infusion settings specific to a particular care area or therapy.

If PERSONALITY feature sets have been configured by the facility, the clinician can select a different PERSONALITY feature set when the pump is powered on. The PERSONALITY feature set can only be changed at power on. For instructions on selecting a PERSONALITY feature set, see “Selecting a Pump PERSONALITY Feature Set,” 4-5.

The Permanent Settings PERSONALITY feature set is the factory default and its parameters cannot be changed, but it can be copied and modified to create custom PERSONALITY feature sets tailored to the needs of the facility. See “Configurable Options,” 6-1, for the default settings.

PERSONALITY feature sets should be created only by facility-authorized personnel, and the settings should be based upon clinical protocols. An access code is required to program PERSONALITY feature sets. See the *COLLEAGUE Pump Configuration Manual* or the COLLEAGUE GUARDIAN Configuration Tool documentation for more information.

Label Library

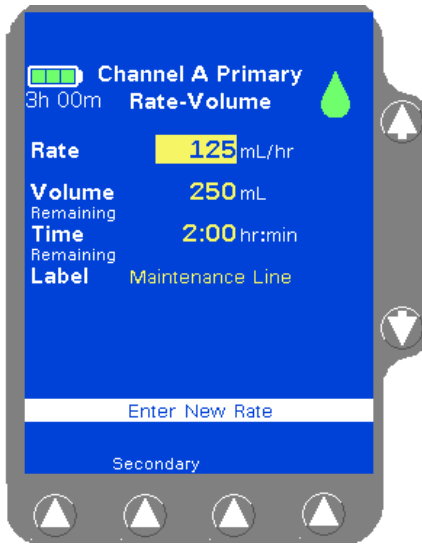

Figure 2-9 Programming Screen with Label

This configurable feature allows the user to select informational labels for display on the Programming screen (Figure 2-9) and Main Display screen (Figure 2-10), and an eight-character abbreviation of the label on the Pump Module display. For information on selecting a label during programming, see “Selecting a Label,” 4-24.

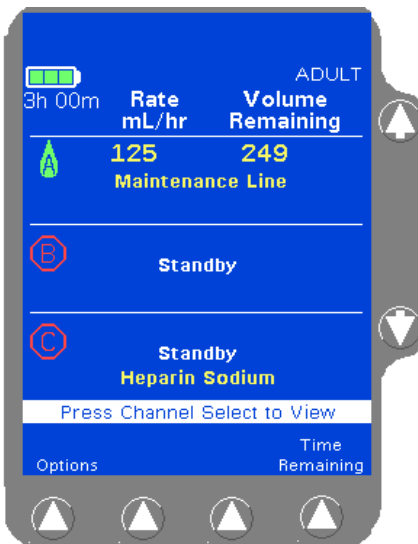

Figure 2-10 Main Display with Label

Labels are chosen from a list of predefined or custom labels. When the Label Library feature is enabled, the user can select from the list of available labels. For a list of predefined labels, see “Predefined Labels” on page 6-7.

When the label library is viewed, the application labels are listed first, followed by the medication/solution labels. For a list of application labels, see “Application Labels,” 6-9.

Infusion Modes

The infusion modes and programming functions available on the pump depend on the facility-authorized configuration.

Rate-Volume Infusions

This mode allows programming the flow rate and the infusion volume, and the pump then runs at the programmed rate until the programmed volume has been delivered. The pump then switches to the KVO (Keep Vein Open) rate.

Rate-volume infusions can be programmed for primary or secondary infusions. Secondary rate-volume infusions can be programmed without stopping the primary infusion.

For instructions on programming rate-volume infusions, see “Programming a Primary Rate-Volume Infusion,” 4-21 and “Programming a Secondary Rate-Volume Infusion,” 4-50.

Volume-Time Infusions

This infusion mode lets the user enter the Volume to be Infused and Time Duration, and the pump then calculates and displays the flow rate.

This feature is available in primary and secondary modes. Secondary infusions can be programmed in Volume-Time without stopping the primary infusion.

For instructions on programming Volume-Time infusions, see “Programming a Primary Volume-Time Infusion,” 4-25 and “Programming a Secondary Volume-Time Infusion,” 4-52.

COLLEAGUE GUARDIAN Feature

The COLLEAGUE GUARDIAN feature is a configurable option that helps to reduce the potential for medication programming errors by allowing program limits to be predefined for labels in the pump's label library, including custom labels, based on facility or care area protocols.

The COLLEAGUE GUARDIAN feature allows the clinician to compare pump programming with facility-defined dose guidelines at the point of care. If the clinician programs values outside of the rule sets the facility has programmed for a label, an out of limits warning occurs. The COLLEAGUE GUARDIAN feature can be configured for rate-volume and dose mode programming.

Note: All of the setup required to use the COLLEAGUE GUARDIAN feature must be completed by facility-authorized personnel according to the instructions in the *COLLEAGUE Pump Configuration Manual* or the instructions accompanying the COLLEAGUE GUARDIAN Configuration Tool.

General information about the COLLEAGUE GUARDIAN feature is listed below.

- Labels configured with limits using the COLLEAGUE GUARDIAN feature appear in a separate list. The list of COLLEAGUE GUARDIAN labels is accessed by pressing the **Colleague Guardian** soft key from the Primary Rate-Volume or Volume-Time programming screen, or by pressing the **Change Mode** soft key and selecting **Colleague Guardian** from the Programming Modes menu.
- Labels selected from the COLLEAGUE GUARDIAN list have predefined program limits. If the clinician chooses to change the program so that the predefined limits are overridden, a warning is displayed. The warning pop-up includes the programmed dose and the preprogrammed dose limits. The clinician can choose to cancel the dose and reprogram within the limits, or accept the dose and override the limits. See Figure 2-11 for an example of the Limits Warning pop-up.

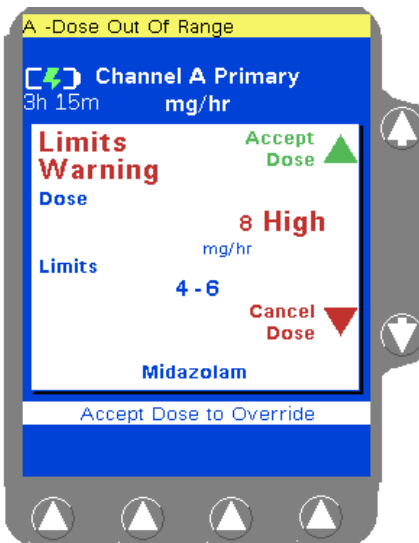

Figure 2-11 COLLEAGUE GUARDIAN Limits Warning Pop-up Example

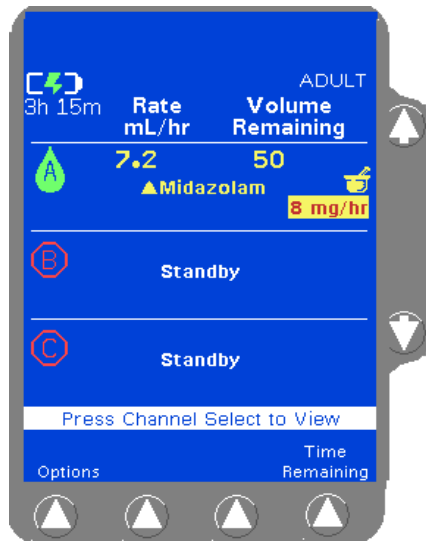

Figure 2-12 Infusion with COLLEAGUE GUARDIAN Limit Override

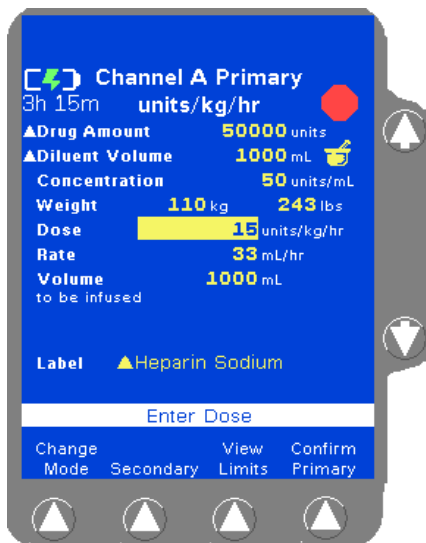



Figure 2-13 COLLEAGUE GUARDIAN Programming Screen—Example of Non-Standard Weight-Based Dose

- On the Main Display, the flow rate for infusions for which the clinician chose to override the predefined limits are displayed in red text on a yellow background. See Figure 2-12 for an example of a Main Display screen for an infusion that overrides the COLLEAGUE GUARDIAN feature limits. The triangle next to the Midazolam label indicates that the standard concentration has been edited from the predefined values.
- Infusions utilizing the COLLEAGUE GUARDIAN feature are identified on the pump's information and programming screens by the mortar and pestle icon  to the right of the infusion information. See Figure 2-12 and Figure 2-13 for examples.
- The COLLEAGUE GUARDIAN feature can be used for primary infusions only. A secondary infusion can be programmed to run with a primary infusion that utilizes the COLLEAGUE GUARDIAN feature.

- COLLEAGUE GUARDIAN parameters can be set by authorized facility personnel for labels in the pump's label library, for any primary dose mode and rate-volume infusions.
- An optional default dose may be preconfigured; if so, the **Dose** field is prefilled on the programming screen when the label is selected.
- For dose modes, COLLEAGUE GUARDIAN parameters can be configured to allow changes to the standard concentration.
 - If changes to standard concentration *are not* allowed, the **Diluent Volume** and **Concentration** fields *cannot* be edited by the clinician when programming an infusion.
 - If changes to standard concentration *are* allowed, the **Diluent Volume** and **Concentration** fields *can* be edited by the clinician when programming an infusion. White triangles appear beside the field names for fields that have been edited. In the example shown in Figure 2-13, the clinician has changed the **Drug Amount** and **Diluent Volume** fields to values that differ from the programmed COLLEAGUE GUARDIAN feature limits for Heparin Sodium. The yellow triangle beside the Heparin Sodium label indicates that the concentration can be edited.

For instructions on programming infusions using the COLLEAGUE GUARDIAN feature, see “Programming a Primary COLLEAGUE GUARDIAN Infusion (Non-Weight-Based),” 4-31 and “Programming a Primary COLLEAGUE GUARDIAN Infusion (Weight-Based),” 4-34.

Dose Modes

Dose programming lets the user program a primary infusion using dose parameters. The dose can be programmed independent of patient parameters or based on patient body weight. The following dose modes are allowed:

- General (independent of patient parameters)
 - mg/hr
 - mEq/hr
 - mg/min
 - mcg/hr
 - units/hr
 - mcg/min
- Based on patient body weight
 - mg/kg/hr
 - mEq/kg/hr
 - mg/kg/min
 - mcg/kg/hr
 - units/kg/hr
 - mcg/kg/min

How Concentration is Determined

Concentration is a required infusion parameter. Concentration is determined by dividing the drug amount into the diluent volume. If the concentration is known, it can be entered directly into the pump. If concentration is the first parameter entered, the **Drug Amount** and **Diluent Volume** fields are cleared.

How Doses and Rates are Calculated

Concentration must be entered or calculated before the rate or dose can be calculated. After the dose is entered, the pump calculates and displays the rate. Similarly, after the rate is entered, the pump calculates and displays the dose.

Conversion factors are applied as appropriate to calculate rate or dose (i.e., 60 minutes = 1 hour, 1000 mcg = 1 mg, etc.).

To calculate rate from an entered dose, the following formulas are applied:

- General:

$$\text{Rate} = \frac{\text{Dose}}{\text{Concentration}}$$

- Based on patient body weight:

$$\text{Rate} = \frac{\text{Dose} \times \text{Patient Weight}}{\text{Concentration}}$$

To calculate dose from an entered rate, the following formulas are applied:

- General:

$$\text{Dose} = \text{Rate} \times \text{Concentration}$$

- Based on patient body weight:

$$\text{Dose} = \frac{\text{Rate} \times \text{Concentration}}{\text{Patient Weight}}$$

To calculate rate from an entered volume to be infused and entered time of infusion, the following formula is applied:

$$\text{Rate} = \frac{\text{Volume to be Infused}}{\text{Time of Infusion}}$$

Changing a Parameter After All Parameters Have Been Entered

If all parameters have been entered and calculated and one of the parameters is changed, one or more of the following occurs:

- If the actual Dose is changed, the Rate is automatically recalculated, or vice versa.
- If the Drug Amount or Diluent Volume is changed, the Concentration is recalculated.
- If the Concentration is changed, the Drug Amount and Diluent Volume will be cleared.
- If a parameter that could indirectly affect the Dose or Rate (such as patient weight) is changed, the Rate will change but the Dose remains constant.

Changing Units of Measure

Units of measure can be changed for the Drug Amount and Concentration values. Whenever a unit of measure is changed, the pump automatically clears the program values of any parameters associated with the changed units.

For instructions on programming dose infusions, see “Programming a Primary Dose Mode Infusion (Non-Weight Based),” 4-39 and “Programming a Primary Dose Mode Infusion (Weight-Based),” 4-43.

Primary Delay Start Mode

Primary Delay Start is an optional feature available on the Programming Modes menu. If Primary Delay Start does not appear on the Programming Modes menu, this feature has not been enabled. Delay Start lets the user program a primary rate-volume infusion to begin at a specified time, in 24-hour format. A Delay Start infusion starts automatically when the pump’s clock reaches the programmed Start At time. If the pump is displaying a programming screen when the Delay Start infusion begins, the display changes to the Main Display.

When a Delay Start infusion has been programmed, a wristwatch icon is displayed on the Main Display screen (Figure 2-14) until it is time for the infusion to begin.

When a Delay Start infusion begins, the pump channel’s infusion mode changes to primary rate-volume and the main display shows the programmed infusion information. The wristwatch icon changes to the stop icon or the drop icon, depending upon whether the infusion is stopped or running.

The **Secondary** soft key for the channel is not available until the Delay Start infusion starts running.

For instructions on programming Delay Start infusions, see “Programming a Delay Start Infusion,” 4-62.



Figure 2-14 Primary Delay Start Infusion Pending

Preparation for Use

Environmental Conditions

The pump should be operated within the following environmental conditions in order to meet the pump's performance specifications:

- Temperature: 15°C to 38°C (59°F to 100°F)
- Relative Humidity: 20% to 95% (non-condensing)
- Barometric Pressure: 70 to 106 kPa

! WARNING !

Do not use this pump in Linear Accelerator Radiation Therapy suites or Magnetic Resonance Imaging Suites.

Setup Instructions

Initial Installation

To ensure safe and proper operation, read the manual and any instructions accompanying disposables or accessories before operating this device.

To charge a new pump's batteries:

1. Plug the power cord into a 100-120 VAC 50/60 Hz or 220-240 VAC 50/60 Hz outlet
2. Confirm that the plug icon is lit. This indicates that the batteries are charging.

3. Before initially powering on the pump, charge the battery for at least 12 uninterrupted hours. A complete charge may take longer than 12 hours.

Mounting the Pump on an IV Pole

CAUTION

When attaching this pump to an IV pole, ensure it has been securely clamped and ensure that the IV pole is stable and secure. Ensure that the pole is able to support the pump, along with any other devices, without tipping or falling. When attached to an IV pole, the pump may become unstable (tip and fall) if the center of the mounting clamp knob (Figure 3-1) measures 96 cm (37.8 inches) or higher from the floor. The pole diameter should be between 0.96 and 3.81 cm (3/8 inch and 1-1/2 inches).

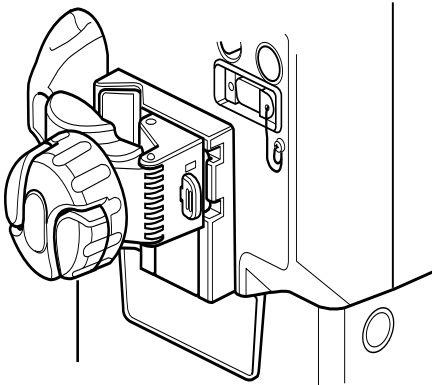

Figure 3-1 Pole Mount

Note: To help loosen the mounting clamp knob, flip open and use the two wing-shaped extensions on the knob.

1. For triple channel pumps: proceed to Step 2.

For single channel pumps: check to see if the clamp bracket is positioned for mounting on a pole as in Figure 3-1. If so, continue with Step 2; otherwise, see “Changing the Mounting Bracket Orientation (Single Channel Pumps Only),” 3-3.

2. Attach mounting clamp by positioning the hinged clamp arm around the IV pole.
3. Turn the mounting clamp knob clockwise to close the clamp arm. Tighten until secure.

Mounting the Pump on a Headboard (Single Channel Pumps Only)

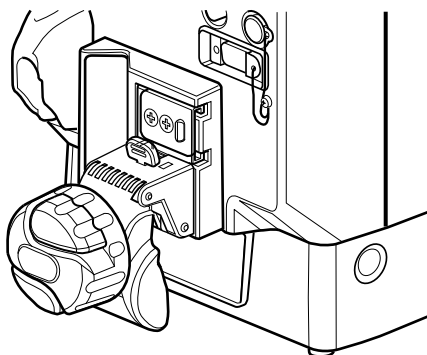

Figure 3-2 Headboard (horizontal) Mount

Note: To help loosen the mounting clamp knob, flip open and use the two wing-shaped extensions on the knob.

1. Check to see if the clamp bracket is positioned for headboard mounting or other horizontal applications as in Figure 3-2. If so, continue with Step 2; otherwise, see “Changing the Mounting Bracket Orientation (Single Channel Pumps Only),” 3-3.
2. Attach mounting clamp by positioning the hinged clamp arm over the chosen fixture.
3. Turn the mounting clamp knob clockwise to close the clamp arm. Tighten until secure.

Changing the Mounting Bracket Orientation (Single Channel Pumps Only)

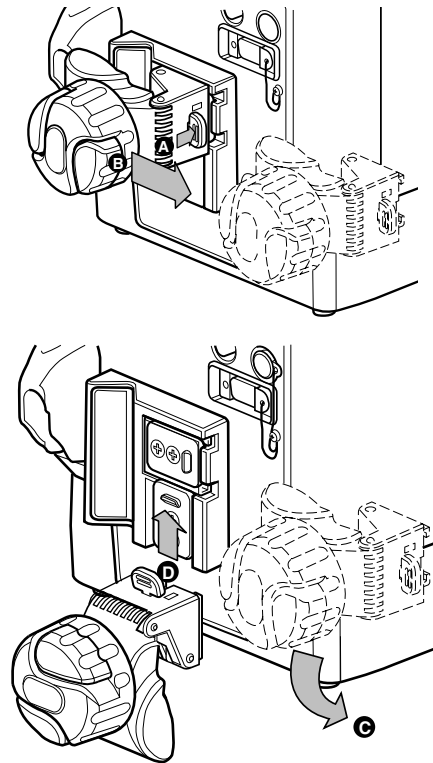

Figure 3-3 Changing the Mounting Bracket Orientation

The instructions and Figure 3-3 illustrate how to change the orientation from a pole mount (vertical) to a headboard (horizontal) mount. The procedure for changing from a horizontal mount to a vertical mount is similar, except that the positions of the clamp and plate cover are the reverse of what is shown in the figures.

1. Press down and hold the latch (A in Figure 3-3) to release the mounting clamp from the plate.
2. Grasp the mounting clamp knob and slide the clamp off of the bracket (B in Figure 3-3).
3. Rotate the clamp counter-clockwise 90° (C in Figure 3-3) until the open end of the clamp is towards the floor (see clamp in Figure 3-2).
4. Slide the clamp up onto the plate until you hear the clamp lock into place (D in Figure 3-3). The clamp should now be positioned as in Figure 3-2.
5. Continue with attaching the clamp according to the applicable mounting procedure above.

Check-out

! WARNING !

If the pump has been dropped or appears to be damaged, it should be taken out of service and inspected by Baxter-trained, qualified personnel only.

Perform the following visual inspections before each use:

- Display screens and keypads: check for wear, scratches, or cracks
- Pump body: check for cracks and dents
- Power cord and plug: check the cord and connectors for cracks and damage. Do not use the pump if the connectors appear damaged.
- Labels: check for scratches, cuts, and peeling, or fading, missing, and obliterated labels and words.

If there is any evidence of damage, contact your authorized service provider.

Operating Instructions

Note: Throughout the Operating Instructions chapters, sample screens for a triple channel pump are shown. See “Display Reference Guide” on page 2-10 for the screen display differences between triple channel pumps and single channel pumps.

Starting Up

Powering On Using AC Power

Note: Pump Status If the pump status is unclear, close any pop-up windows on the display and press the **Main Display** key to continue.

Note: Battery Power If the pump is operating on battery power at start up, refer to “Powering On Using Battery Power” on page 4-6.

Note: Manual Tube Release The pump will not turn on if the Manual Tube Release is in the open position.

The power cord must be connected to a 100-120 VAC 50/60 Hz or 220-240 VAC 50/60 Hz, properly grounded 3-wire receptacle.

Grounding reliability can only be achieved when the pump is connected to an earth-grounded hospital grade receptacle. (When grounding reliability is in doubt, the pump should be powered by its battery.) The

power cord must be disconnected from the power outlet (supply receptacle) in order to disconnect the pump from AC power (mains supply).

Self-diagnostic testing occurs whenever the pump is powered ON. If any of the following occur during self-diagnostic testing, the pump must be removed from service and inspected by Baxter-trained, qualified personnel:

- Dark spots or lines on Main Display while display is all white.
 - Light spots or lines on Main Display while display is all dark.
 - Portions of pump module displays do not light.
 - LEDs or the plug icon are not lit, or the battery icon is lit.
 - A series of three beeps, with two different tones, is not heard during self-diagnostic test.
 - Audible speaker is not heard during speaker test.
 - Damaged Battery icon is displayed on power-on screens. If a **Damaged Battery! Service Now** alarm occurs during power on, the pump cannot be used. See “About the Damaged Battery Alarm,” 8-8.
1. With the pump plugged in, press the **ON/OFF CHARGE** key. Self-diagnostic tests begin.
 - a. The Main Display and pump module displays turn on.
 - b. The entire Main Display becomes light.
 - c. The entire Main Display becomes dark.
 - d. All 8 digits of all three pump module displays light fully, then display **CLOSED** (Figure 4-1), then turn off completely.
 - e. All the LEDs and icons light briefly. The plug icon lights and remains lit.



Figure 4-1 Pump Module Display

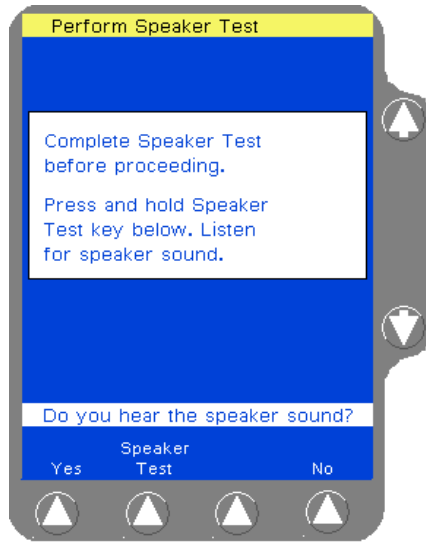

Figure 4-2 Speaker Test Screen

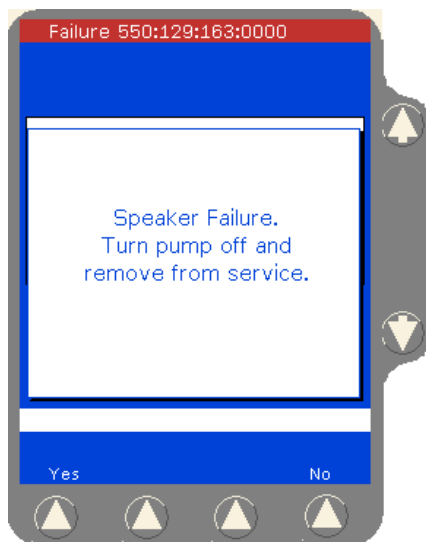

Figure 4-3 Speaker Test Failure

2. If the pump is running on AC power, the Main Display prompts the user to perform the speaker test. This helps ensure that alarms and alerts are audible and that the volume level is appropriate for the care area. If the speaker test is not initiated within 10 minutes, the pump turns itself off automatically.

Press and hold the **Speaker Test** soft key to begin the audible speaker test. The pump produces sound for as long as the key is pressed. The volume control on the pump handle can be adjusted if necessary to hear the speaker. The key must be held down until **Yes** and **No** soft keys are displayed (Figure 4-2).

3. Do one of the following:
 - 3.1 If the continuous tone is heard, press the **Yes** soft key. The pump completes its self-test and then displays the Power On Screen After Self-Test (Figure 4-4).
 - 3.2 If the continuous tone is not heard, even after adjusting the volume control, press the **No** soft key. The pump displays a pop-up to confirm whether the continuous tone is heard. Press the **No** soft key again to confirm that no tone is heard.

The pump displays the speaker failure message shown in Figure 4-3. If this occurs, do not use the pump. Turn the pump off and have it repaired as described in “Troubleshooting Failures,” 8-2.

If the continuous tone is not heard during the speaker test, alarms and alerts may not be audible during operation. Do not use the pump. Send the pump to service.

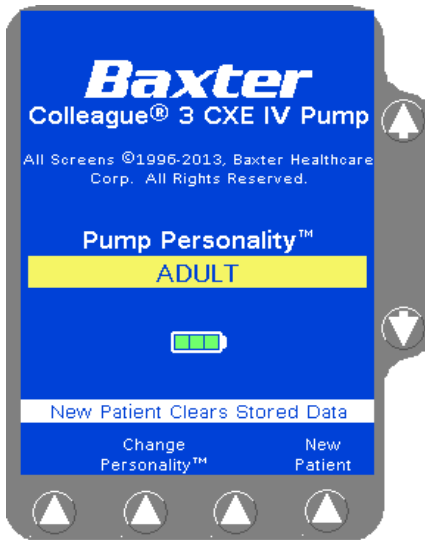

Figure 4-4 Power On Screen After Self-Test

- On completion of all self-diagnostic tests, the Power On screen changes to the display shown in Figure 4-4 (for triple channel pumps, Channels B and C power off after self-diagnostic tests complete). The soft keys available on this screen depend on the configuration options selected for the pump:

- To clear all programming memory and volume history, press the **New Patient** soft key.

Note: The **New Patient** soft key is available for approximately 10 seconds. If the key is not pressed within that time, the pump will retain the previously programmed information. To select the New Patient option after the soft key is no longer available, the pump must be powered off and powered back on.

- Pressing the **Change Personality** soft key changes the display to the Pump PERSONALITY feature set selection screen where available preconfigured pump parameters can be selected. Changing the PERSONALITY feature set also clears the volume history and the programming parameter settings such as Rate and Volume to be Infused.

See “Selecting a Pump PERSONALITY Feature Set,” 4-5 for additional information.

If no keys are pressed, the pump will automatically display the Main Display screen after approximately 10 seconds.

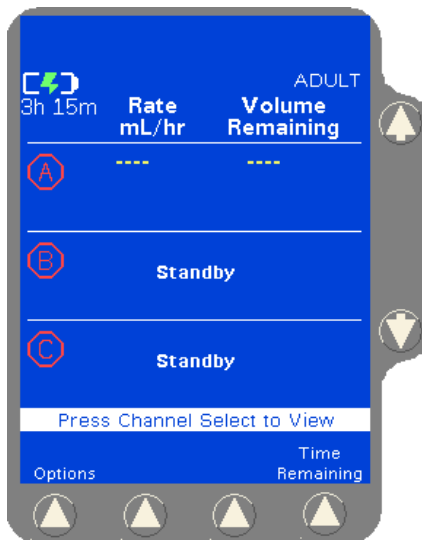

Figure 4-5 Main Display After Self-Test

Selecting a Pump PERSONALITY Feature Set

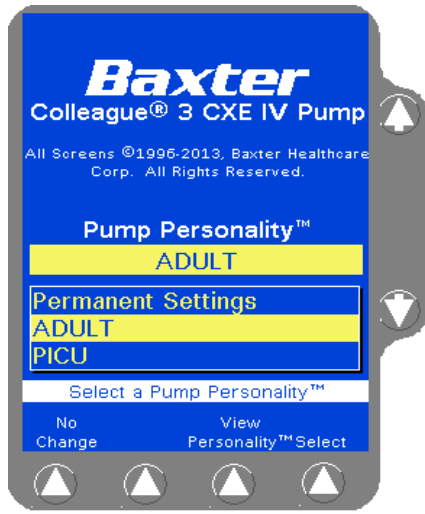

Figure 4-6 Example of Custom PERSONALITY Feature Sets

The PERSONALITY feature set can only be changed at power on. Changing the PERSONALITY feature set also clears the volume history and the programming parameter settings such as Rate and Volume to be Infused.

To change the PERSONALITY feature set:

1. Press the **Change Personality** soft key from the Power On Screen after Self Test (Figure 4-4). A list of available PERSONALITY feature sets is displayed.
2. Use the $\uparrow\downarrow$ keys to highlight the desired PERSONALITY feature set (Figure 4-6).
3. Press the **Select** soft key.

Viewing PERSONALITY Feature Settings at Power-Up

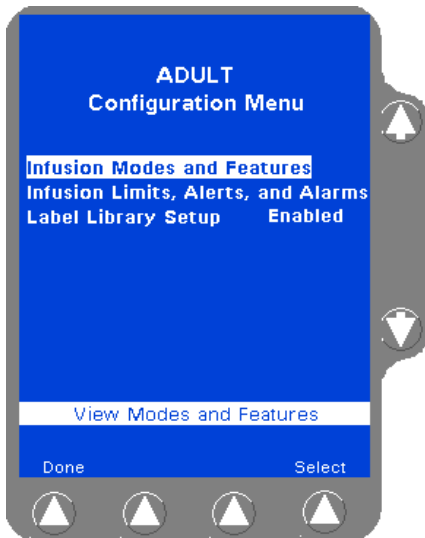

Figure 4-7 Configuration Screen Example

To view the settings for all the parameters of a PERSONALITY feature set:

1. Turn the pump on, then press the **Change Personality** soft key. Use the $\uparrow\downarrow$ keys to highlight the desired PERSONALITY feature set, then press the **View Personality** soft key to view the Configuration menu for the selected PERSONALITY feature set (Figure 4-7).
2. Use the $\uparrow\downarrow$ keys to highlight the desired configuration item. Press the **Select** soft key to view the details for the selected configuration setting.
3. Press **Done** to exit.

Adjusting the Audible Volume

To adjust the volume of the audible tones produced by the pump:

1. Locate the volume control on rear of the device handle.
2. Rotate the volume control to increase or decrease the volume as needed.

Adjusting the Display Contrast

To adjust the contrast of the pump's main display:

1. Locate the contrast control on rear of the device handle.
2. Rotate the contrast control to increase or decrease the contrast as needed.

Powering On Using Battery Power

Full/Partial Battery Charge

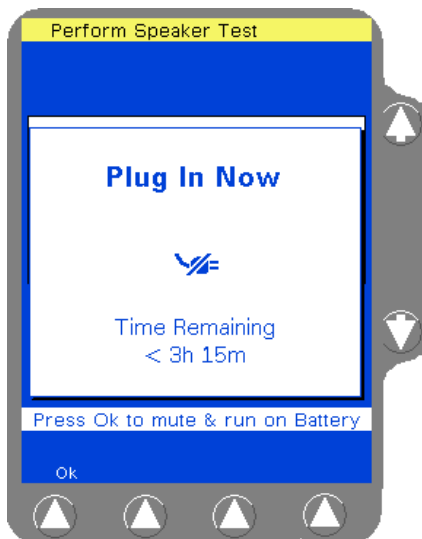

Figure 4-8 Plug in Now Pop-up

If the pump is powered up on battery power, a Plug In Now pop-up is displayed (Figure 4-8) prior to the speaker test, showing the approximate battery time remaining and prompting the user to plug the pump into an AC power outlet.

- To continue on battery power, press the **Ok** soft key. See “Operating on Battery Power,” 4-8 for more information.
- To continue on AC power, plug the pump into an AC outlet.

The Main Display then prompts the user to perform the speaker test. Proceed to step 2 on page 4-3.

Low Battery Condition



Figure 4-9 Plug in Now Alert Pop-up, Low Battery Condition

If the pump is powered up on battery power and a Low Battery condition exists, a Plug In Now alert pop-up is displayed (Figure 4-9) prior to the speaker test, alerting the user that there is less than 30 minutes of battery time remaining. Using battery mode is NOT recommended when this alert occurs.

- To continue on battery power, press the **Ok** soft key. See “Operating on Battery Power,” 4-8 for more information.
- To continue on AC power, plug the pump into an AC outlet.

The Main Display then prompts the user to perform the speaker test. Proceed to step 2 on page 4-3.

Depleted Battery Condition

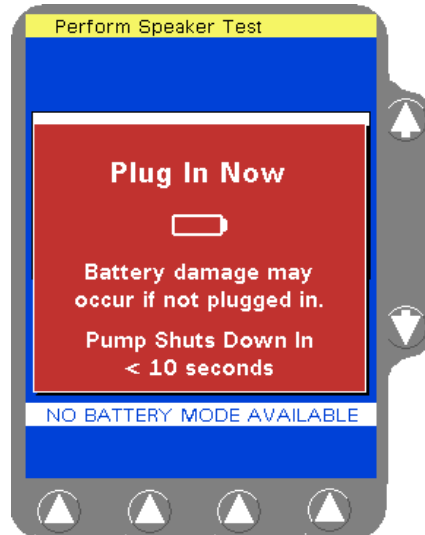

Figure 4-10 Plug in Now Alarm Pop-up, Depleted Battery Condition

If the pump is powered up on battery power and a Depleted Battery condition exists, a Plug In Now alarm pop-up is displayed prior to the speaker test, alerting the user that battery damage will occur if the pump is not plugged in, and the pump will shut down in less than 10 seconds (Figure 4-10).

To continue on AC power, plug the pump into an AC outlet. A pop-up is displayed alerting the user that the pump is charging and must be allowed to sufficiently recharge the battery before operating on battery power. Press the **Ok** soft key. The Main Display then prompts the user to perform the speaker test. Proceed to step 2 on page 4-3.

Operating on Battery Power

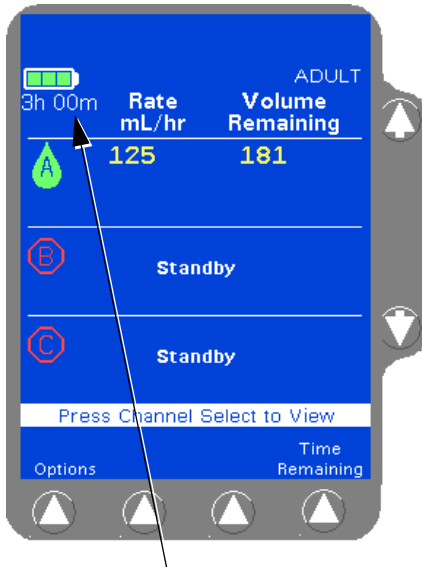

Figure 4-11 Battery Charge Icon on Main Display

The pump can be battery-powered in emergency situations and while transporting patients. AC power should be used when not transporting patients.

The battery charge icon is displayed at all times in the upper left part of the screen, even when the device is operating on AC power (Figure 4-11). When the pump is unplugged and operating on battery power, the battery charge icon alternates with the Plug In icon, and the approximate battery operating time is displayed below the icon.

Charge the battery for at least 12 uninterrupted hours or until the battery operating time displayed under the battery charge icon in the upper left part of the screen is 3h 15m (for triple channel pumps) or 4h 00m (for single channel pumps). A complete charge may take longer than 12 hours.

Battery time remaining adjusts based on flow rate; the batteries will discharge at a faster rate at higher infusion rates. If the flow rate is changed during an infusion, the battery time remaining will change accordingly.

Battery Charge Icon Descriptions

See Table 4-1 for a list of battery charge icons and their meaning. Battery time remaining is approximate.

Table 4-1 Battery Charge Icons and Descriptions













Icon	Description
	The battery charge icon is displayed at all times in the upper left part of the screen. The number of filled areas in the battery charge icon is an approximate indication of the battery charge level. When the battery time remaining is 80 to 100%, the icon contains three green bars as shown at left.
	As the battery charge level decreases, the battery charge icon changes. When the battery time remaining is 60 to 80%, the icon contains two green bars as shown at left.
	As the battery charge level continues to decrease, the battery charge icon continues to change. When the battery time remaining is at 20 to 60%, the icon contains two yellow bars as shown at left.
	When the battery time remaining is less than 20%, the battery charge icon contains one red bar as shown at left.

Table 4-1 Battery Charge Icons and Descriptions — continued

Icon	Description
	<p>When the battery time remaining is only 5 minutes, the battery charge icon appears as an empty outline as shown at left. The icon will remain an empty outline until the battery is depleted and pump shuts itself off.</p>
	<p>If the pump's batteries need replacement when the pump is first powered on, or during operation without an infusion running, a Damaged Battery! Service Now alarm occurs and this icon flashes on the Power On screen. The pump cannot be used. Send the pump to service.</p> <p>If the pump's batteries need replacement while an infusion is running, a Damaged Battery! Service Now alert occurs and this icon flashes instead of the battery charge icon. Ensure the pump is plugged into AC power. Do not use the pump for transport. Have the pump serviced as soon as possible so the batteries can be replaced.</p>
	<p>When the pump is plugged in, the battery charge icon alternates with the charging icon shown at left.</p>
	<p>When the pump is unplugged and operating on battery power, the battery charge icon alternates with the Plug In icon shown at left, and the approximate battery operating time is displayed below the icon. The pump should be plugged in whenever possible to maintain battery charge.</p>

The batteries begin to recharge whenever the pump is plugged into AC power. If there is less than 30 minutes of battery time remaining when recharge begins, the pump will display the empty outline battery charge icon  until 30 minutes of battery time is achieved. The pump will then display the battery charge icon with one red bar  up until the point when the maximum charge is achieved, at which time the battery charge icon will display three green bars . The time remaining on battery will continue to display the time remaining when the pump was plugged in until the maximum charge is achieved.

If there is more than 30 minutes of battery time remaining when the recharge begins, the pump will continue to display the battery charge icon that was present when the recharge began up until the point when the maximum charge is achieved, at which time the battery charge icon will display three green bars . The time remaining on battery will continue to display the time remaining when the pump was plugged in until the maximum charge is achieved.

CAUTION

When charging the batteries, ensure the room temperature is between 15° C (59° F) to 30° C (86° F) to minimize charge time and maximize battery life.

Battery Charge Alerts and Alarms

As the pump runs on battery and remaining battery time decreases, a progression of alerts and alarms advise the user of the declining battery power. These alerts and alarms are described below.

For additional information, see “Troubleshooting,” 8-1.

When the pump first begins to run on battery power, the **Running on Battery - Plug In Now** alert occurs. An audible tone sounds and a Plug In Now pop-up window displays (Figure 4-12), alerting the user that the pump is operating on battery power and showing the approximate battery time remaining. The pop-up will reappear every hour, counting down the battery time until the battery time remaining reaches 60 minutes.

Pressing the **Ok** soft key will silence the alert and clear the pop-up; however, the status line will continue to show the message **Running on Battery - Plug In Now**.



Figure 4-12 Running on Battery Alert Pop-up



Figure 4-13 Limited Battery Alert Pop-up

When the battery time remaining reaches 60 minutes, the **Limited Battery - Plug In Now** alert occurs. An audible tone sounds and a Plug In Now pop-up window displays (Figure 4-13), alerting the user that the pump is operating on battery power and showing the approximate battery time remaining.

Pressing the **Ok** soft key will silence the alert and clear the pop-up; however, the status line will continue to show the message **Limited Battery - Plug In Now**.



Figure 4-14 *LOW Battery Alert Pop-up*

When the battery time remaining reaches 30 minutes, the **LOW Battery - Plug In Now** alert occurs. An audible tone sounds and a Plug In Now pop-up window displays (Figure 4-14), alerting the user that infusions will stop in less than 30 minutes. The pop-up will reappear every 5 minutes counting down the battery time until the battery time remaining reaches 5 minutes.

Pressing the **Ok** soft key will clear the pop-up but will not silence the audible tone. Pressing the **Alarm Silence** key will silence the tone for two minutes. The status line will continue to show the message **LOW Battery - Plug In Now**.



Figure 4-15 *DEPLETED Battery Alert Pop-up*

When the battery time remaining reaches 5 minutes, the **DEPLETED Battery - Plug In Now** alert occurs. An audible tone sounds and a Plug In Now pop-up window displays (Figure 4-15), alerting the user that infusions will stop in less than 5 minutes. The pop-up will reappear every minute until the battery is depleted.

Pressing the **Ok** soft key will clear the pop-up but will not silence the audible tone. The status line will continue to show the message **DEPLETED Battery - Plug In Now**.

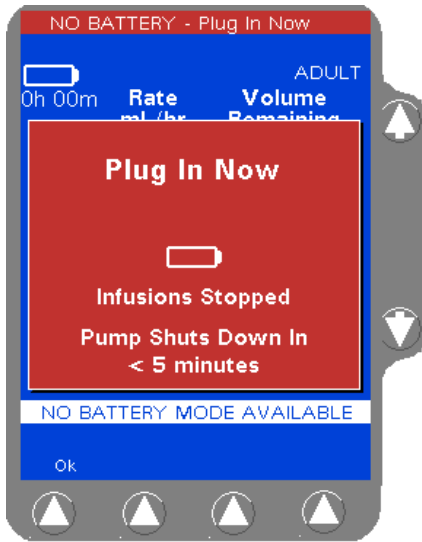

Figure 4-16 NO BATTERY Alarm Pop-up

When the battery is fully depleted, the **NO BATTERY - Plug In Now** alarm occurs. An audible tone sounds and a Plug In Now pop-up window displays (Figure 4-16), alerting the user that infusions have stopped and the pump will shut down in less than 5 minutes. The pop-up will reappear every minute until the pump shuts down.

Pressing the **Ok** soft key will clear the pop-up but will not silence the audible tone. The status line will continue to show the message **NO Battery - Plug In Now** until the pump shuts down.

When the **NO BATTERY - Plug in Now** alarm occurs plug the pump in immediately. Do not use the pump on battery power until the batteries have been fully recharged. Charge the battery for at least 12 uninterrupted hours or until the battery operating time displayed under the battery charge icon in the upper left part of the screen is 3h 15m (for triple channel pumps) or 4h 00m (for single channel pumps). A complete charge may take longer than 12 hours.

Battery Charge Progress Indicator Alert

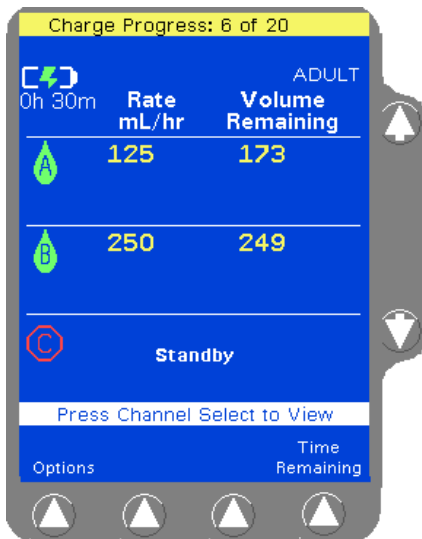

Figure 4-17 Charge Progress Indicator

When the pump is plugged into AC power after operating on battery power, a Charge Progress Indicator alert occurs. The purpose of this alert is to notify the user that the battery is charging, and to give an approximation of charge progress.

In the status line area at the top of the display (Figure 4-17), the charging progress is shown using a scale of 1-20, with 20 equalling a full battery charge.

Note: There is no audible tone associated with the Charge Progress Indicator alert.

Note: Recharge time may vary depending on battery life.

Damaged Battery Alert and Alarm

See “Troubleshooting,” 8-1 for information about the damaged battery alarm and alert.

Preparing for an Infusion

Preparing the Primary Infusion Container and Set

! WARNING!

Always read and follow the instructions which accompany the source container and administration sets you are using. Carefully follow any label copy instructions for loading, removing, and reloading the set, as well as the recommended set change interval. For optimal pump performance, set use should not exceed the change interval shown on the set's label copy or 72 hours, whichever is less.

! WARNING!

Clinicians are advised to verify the proper route of delivery and that the infusion site is patent. When using this pump, periodic patient monitoring must be performed to ensure that the infusion is proceeding as expected. The pump is capable of developing positive fluid pressures to overcome widely varying resistances to flow such as resistance imposed by small-gauge catheters, filters, or intra-arterial infusions. Although the pump is designed to stop fluid flow when an alarm occurs, it is neither designed nor intended to detect infiltrations and will not alarm under infiltration conditions.

! WARNING !

The pump may not detect an upstream occlusion if one or more of the following conditions exist:

- All air removed from the source container
- Incomplete insertion of the spike into the source container
- Improper venting of a rigid (glass bottle) or semi-rigid (plastic) container, including BURETROL sets

If using rigid non-vented containers, refer to the appropriate administration set instructions to determine the correct venting procedure.

- The air vent above the burette chamber is not open

To help prevent upstream occlusions that may not be detected by the pump:

- Do not use a source container that has had all air removed.
- When using a BURETROL set, do not invert BURETROL and squeeze fluid into the primary container, which may wet out the vent filter and obstruct airflow.

For infection control purposes, consider the set change interval recommended by the United States Centers for Disease Control and Prevention (CDC), the facility's guidelines, and the instructions provided with the administration set.

1. Spike the primary solution container and prime the administration set following the manufacturer's directions for use.

Note: The optional Prime function may also be used (see "Using the Optional Prime Function" on page 4-18).

2. Ensure all air is expelled from the administration set.
3. **Close the regulating clamp on the administration set.**

Replacing the Primary Infusion Container (Using the Same Administration Set)

! WARNING !

Laying the infusion source container flat during an infusion increases the potential for air to enter the tubing, resulting in an Air in Line alarm and interruption of patient therapy.

1. If the pump module is running, press the **STOP** key on the pump module to stop it.
2. **Close the regulating clamp on the administration set.**
3. Unload the administration set from the pump module (see “Unloading the Administration Set,” 4-78) and detach the administration set from the empty infusion container.
4. Follow the instructions for “Preparing the Primary Infusion Container and Set” starting at step 1 on page 4-14.

Recommended Administration Sets

! WARNING !

Use only Baxter standard administration sets equipped with keyed slide clamps that are labeled as being COLLEAGUE pump compatible or denoted with an “s” in the product code. If you have questions about administration set compatibility, contact the Baxter Product Information Center at the number shown on the administration set labeling. Using anything other than the recommended administration sets with this pump will result in operation that is not within the constraints and parameters of the device.

Severe injury or death may result from using sets other than those approved by Baxter Healthcare Corporation for use with COLLEAGUE pumps. Always read and follow the instructions in the Operator’s Manual and those accompanying the set and source container.

Loading the Administration Set

Note: The pump must be powered on to load the administration set (see “Powering On Using AC Power,” 4-1).

If the administration set is not loaded after the **Open** key has been pressed, the mechanism closes automatically after 60 seconds.

Never use the Manual Tube Release to load or unload the administration set during normal operation.

! WARNING !

Pulling or tugging on the administration set tubing between the pump channel and the patient may cause false Air Detected alarms, which will cause the pump to stop infusing. In order to reduce the potential for this situation to occur:

- First, select an appropriate length administration set.
- Before loading the set into the pump, position the keyed slide clamp at an appropriate location along the tube segment to ensure that there is adequate length of tubing between the patient and the pump to reduce tugging on the set.
- Lastly, ensure there is sufficient slack in the tubing between the distal end of the tubing channel and the patient to prevent tube tugging during activities such as moving the patient from one bed to another, or transportation of the patient from one facility location to another.

In order to avoid false alarms, the pump should never be placed on the bed alongside the patient.

! WARNING !

Do not allow fluid to enter the tubing channel or load wet tubing into the pump. Contact your Baxter Service Center for assistance immediately if fluid enters the tubing channel. The tubing channel should be cleaned as soon as possible by Baxter-trained, qualified personnel to minimize potential difficulties caused by fluid pooling and drying on the mechanism. Fluid in the tubing channel can also cause false Air In Line alarms. See “Authorized Service Centers,” 10-2.

CAUTION

When attempting to load or unload an administration set, do not insert tools or other objects into the tubing channel.



Figure 4-18 Pump Module Keys

1. For single channel pumps, press the **Open** key (Figure 4-18).

For triple channel pumps, press the **Channel Select** key for the desired channel, then press the **Open** key.

The automatic tube loading mechanism opens so the administration set can be loaded, and the pump module displays PATIENT alternating with ---->>>>.

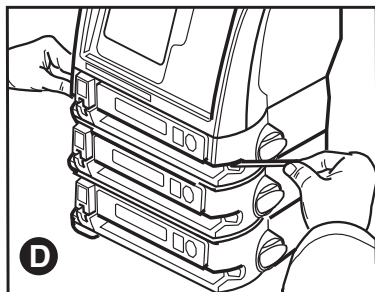
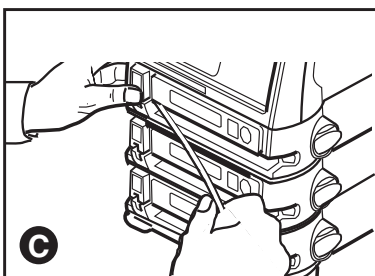
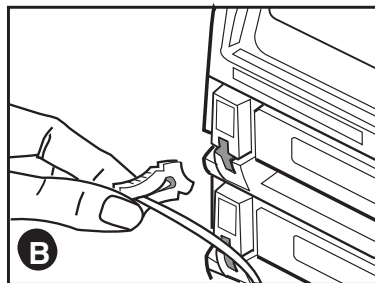
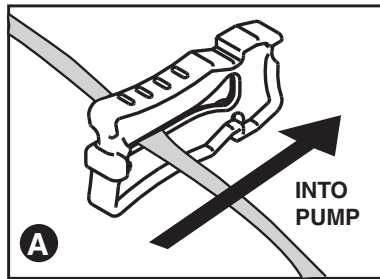

Figure 4-19 Loading the Administration Set

2. Close the keyed slide clamp on the administration set so it occludes the tubing to prevent free flow. Hold the keyed slide clamp with the notched side up (Figure 4-19A).
3. Insert the keyed slide clamp into the slot in the pump (Figure 4-19B).
4. Pull the administration set taut and slide it all the way into and along the tubing channel (Figure 4-19C). The pump pulls in the keyed slide clamp, then loads the administration set into the pumping mechanism (Figure 4-19D). The pump module displays **LOADING**, then **STOPPED**.

Note: A **Tube Misloaded** alarm will occur if the tubing is not loaded properly. See page 8-15 for more information about the **Tube Misloaded** alarm.

5. Confirm that the tubing coming from the source container enters the pump module on the **left** side, and the tubing exiting the pump on the right side goes to the patient as shown in Figure 4-20.

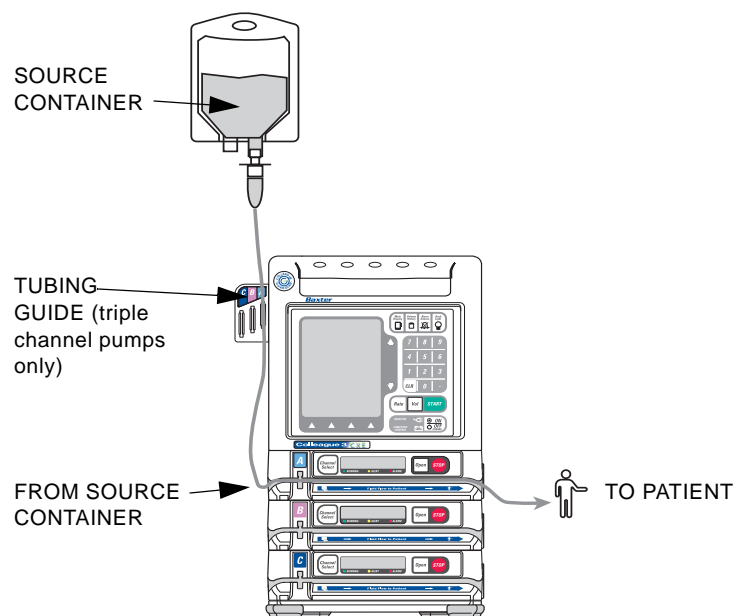

Figure 4-20 Orientation of Source Container, Pump, and Patient

6. Open the regulating clamp. Verify that no solution is flowing (no free flow drops falling in the drip chamber and/or no flow from the end of the administration set).
7. Attach the primed administration set to the patient access site.

8. For triple channel pumps only: Arrange the tubing in the tubing guide according to pump channel.

! WARNING !

If flow is observed when tubing is loaded but the pump is not running, close the regulating clamp immediately. Ensure that all steps have been properly performed. If flow is still observed, remove the pump from service and contact Baxter-trained, qualified personnel.

Using the Optional Prime Function

Overview

The optional Prime function can be used to assist clinicians in preparing a primary administration set for infusion.

If Prime is not displayed on the Programming Modes menu, this feature has not been enabled.

! WARNING !

Do not connect the administration set to the patient when priming.

Priming the Administration Set

Note: The administration set's drip chamber should be at least one third full prior to using the prime function to ensure that fluid will enter the administration set.

Note: Prime cannot be selected if an **Air** alarm is active.

Note: Air detection is disabled when priming is active.

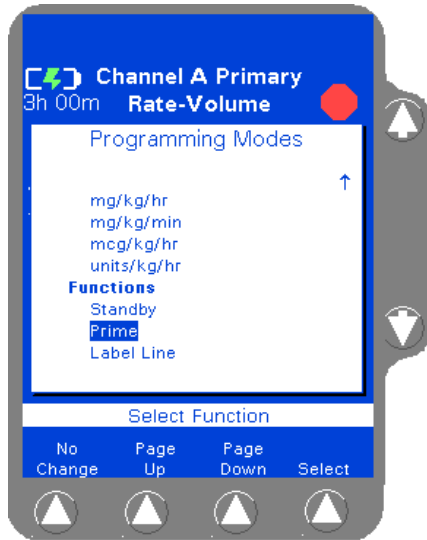

Figure 4-21 Programming Modes Menu



Figure 4-22 Ready to Prime

1. Load the administration set into the desired pump channel as described in “Loading the Administration Set,” 4-16.
2. From the Main Display, access the Programming screen:

<p>For single channel pumps:</p> <p>press the Primary soft key or the Rate or Volume keys.</p>	<p>For triple channel pumps:</p> <p>press the desired Channel Select key.</p>
----------------------------------------------------------------------------------------------------------------------------	---------------------------------------------------------------------------------------------

3. From the Programming screen, press the **Change Mode** soft key. The Programming Modes menu is displayed (Figure 4-21).

4. Use the $\uparrow\downarrow$ keys to highlight **Prime** (under **Functions**), then press the **Select** soft key.

The **PRIME WARNING** pop-up (Figure 4-22) is displayed.



Figure 4-23 Prime Active

5. Press and hold the **Prime** soft key until all the air is expelled from the administration set. The **PRIME ACTIVE** pop-up (Figure 4-23) is displayed while the **Prime** soft key is pressed. Release the **Prime** soft key when finished priming.
6. When priming has been completed, press the **Done** soft key to exit the priming function and return to the channel's primary infusion program screen.

Programming an Infusion

Before starting an infusion, the administration set must be fully loaded.

- If an administration set has not been loaded and **START** is pressed, a **Tube Not Loaded** alarm will occur.
- If an administration set is still loading and **START** is pressed, a **Tube Loading in Progress** alarm will occur.

See Table 8-1, “Troubleshooting Alarm Messages,” on page 8-13 for more information about these alarms.

Primary Infusions

Programming a Primary Rate-Volume Infusion

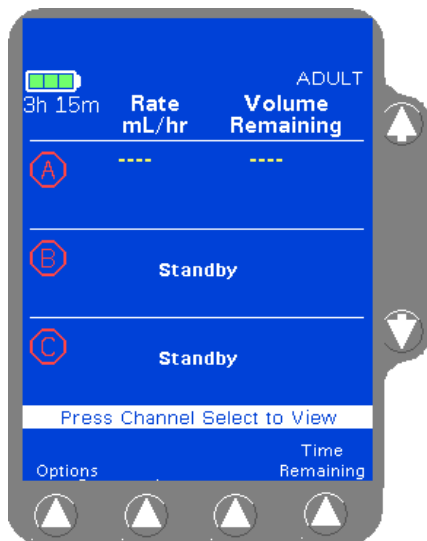

Figure 4-24 Main Display Screen

1. From the Main Display screen (Figure 4-24):

<p>For single channel pumps:</p> <p>press the Primary soft key or the Rate or Volume keys.</p>	<p>For triple channel pumps:</p> <p>press the desired Channel Select key.</p>
----------------------------------------------------------------------------------------------------------------------------	---------------------------------------------------------------------------------------------

The display then changes to the Rate-Volume programming screen (Figure 4-25). The **Rate** field is highlighted.

Note: Channel Stopped Alert
If a pump channel is powered on and no keys are pressed for two minutes, a **Channel Stopped** alert occurs. Either continue programming, start the infusion, or place the channel in standby to clear the alert.

! WARNING !

There may be periods of no flow for flow rates less than or equal to 1mL/hr.

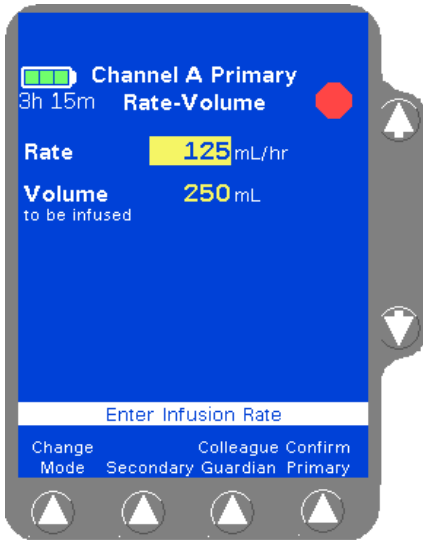

Figure 4-25 Rate-Volume Programming Screen

2. Enter the flow rate using the numeric keypad.
3. Press the **Vol** key or use the $\uparrow\downarrow$ keys to highlight the **Volume to be infused** field.

! WARNING !

Do not enter a Volume to be infused greater than the amount of fluid available in the container.

4. Enter the **Volume to be infused** using the keypad.

Note:
Programming
Tips

If an incorrect value is entered during programming, press the **CLR** key to clear the field, then enter the correct value.

If values that exceed the allowable range available are programmed, **High** or **Low** will be displayed and an **Out of Range** alarm will occur when the **START** key is pressed.

Note:
Time Duration
Greater than
99:59

If the rate and volume entered results in a time duration exceeding 99:59, the time duration will be displayed as **:**. Upon starting the infusion, the pump will properly track the time remaining, although it will continue to display **:** until 99:59 is reached. Then the actual time remaining will display.

Note:
Optional Labels

An optional label may also be selected. See “Selecting a Label” on page 4-24 for details.

5. When all infusion parameters have been entered, verify that:
 - pump programming matches the label on the source container and the physician’s order
 - the loaded administration set is connected to the correct source container and administration route for the programmed infusion
6. Press the **Confirm Primary** soft key.

Note:
Unconfirmed
Primary Program

If the **START** key is pressed before pressing the **Confirm Primary** soft key, an **Unconfirmed Primary Program** alarm occurs and a message is displayed on the prompt line.

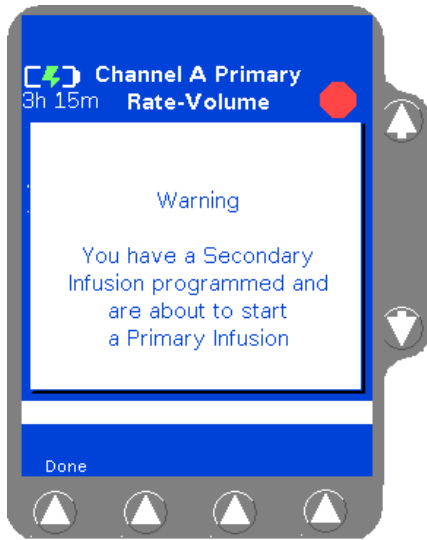

Figure 4-26 Secondary Infusion Programmed Pop-up

7. Press the **START** key to start the infusion.

If a secondary infusion has been programmed but not started, or if any values remain from a stopped secondary infusion, a pop-up appears (Figure 4-26) warning that a primary infusion is about to start when a secondary infusion has been programmed. Press the **Done** soft key to clear the warning and do one of the following:

- Press the **START** key again to start the primary infusion, or
- Press the **Secondary** soft key to access the secondary infusion programming screen. Clear or confirm the secondary infusion program as needed. For more information about secondary infusions, see “Secondary Infusions,” 4-48.

Note: Clearing the values in the secondary program prevents the warning pop-up from reappearing when unintended. Secondary Infusion Warnings

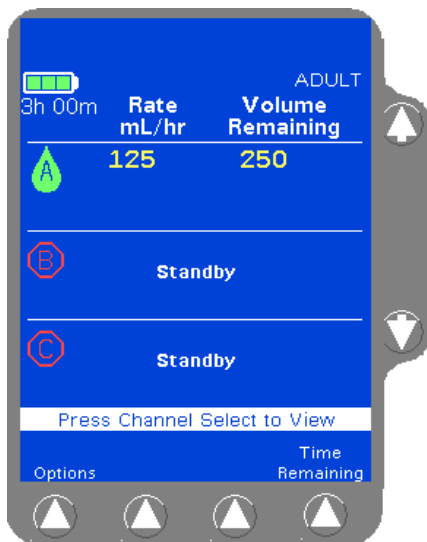

Figure 4-27 Main Display, Primary Running

When the primary infusion starts, the **RUNNING** LED on the Pump Module lights and a moving drop icon is shown on the Main Display (Figure 4-27). Confirm that flow is occurring by observing drops falling into the drip chamber.

Selecting a Label

If the Label Library feature is enabled, use the procedure below to select an informational label for an infusion.

1. Access the desired programming screen:

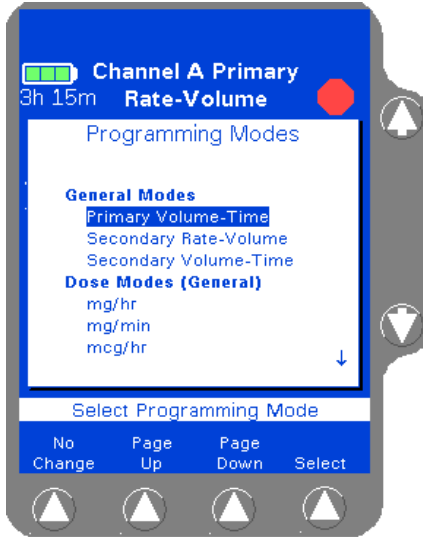

Figure 4-28 Programming Modes Menu

For single channel pumps:	For triple channel pumps:
press the Primary or Secondary soft key.	press the desired Channel Select key.

2. Press the **Change Mode** soft key. The Programming Modes menu is displayed (Figure 4-28).
3. Highlight **Label Line** (under **Functions**) using the $\uparrow\downarrow$ keys, then press the **Select** soft key.

A list of labels and their abbreviations is displayed as shown in Figure 4-29. If the list consists of more than one screen, use the **Page Up** and **Page Down** soft keys to view the next screen of labels.

4. Highlight the label to be selected using the $\uparrow\downarrow$ keys, then press the **Select** soft key. When the **Select** soft key is pressed, the Programming screen is displayed, showing the selected label.

Figure 4-29 shows the label **Maintenance Line** highlighted on the list of available labels.

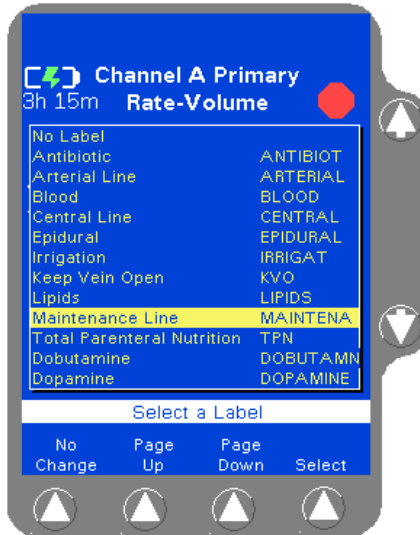

Figure 4-29 Label List

Note: COLLEAGUE GUARDIAN Labels
Labels configured using the COLLEAGUE GUARDIAN feature do not appear in the label list.

Note: Clearing Labels
To clear a label, use the same procedure, but select **No Label** from the label list. **No Label** always appears first in the label list.

Note: Appropriate Label Use
Confirm that the selected label is appropriate for the medication/solution infusing on that channel.

Programming a Primary Volume-Time Infusion

- From the Main Display screen:

<p>For single channel pumps: press the Primary soft key.</p>	<p>For triple channel pumps: press the desired Channel Select key.</p>
--------------------------------------------------------------------------------	------------------------------------------------------------------------------------------

- Press the **Change Mode** soft key. The Programming Modes menu is displayed (Figure 4-30).

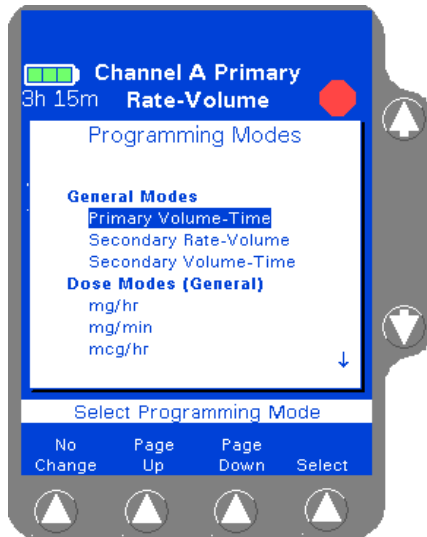

Figure 4-30 Programming Modes Menu

- Highlight **Primary Volume-Time**, then press the **Select** soft key. The Volume-Time Programming screen is displayed (Figure 4-31).
- Enter the **Volume to be infused** using the keypad.
- Highlight **Time Duration** using the $\uparrow\downarrow$ keys. Use the keypad to enter the time period for the infusion in hours and minutes. The pump automatically calculates the flow rate.

The pump may round off the calculated rate. If this occurs, the pump then calculates the time duration based on the rounded rate. When the **Confirm Primary** soft key is pressed, the calculated time is displayed as **Time Remaining** instead of the time duration entered.

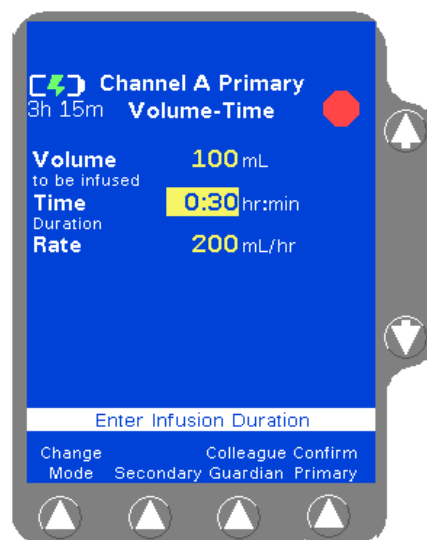

Figure 4-31 Volume-Time Programming Screen

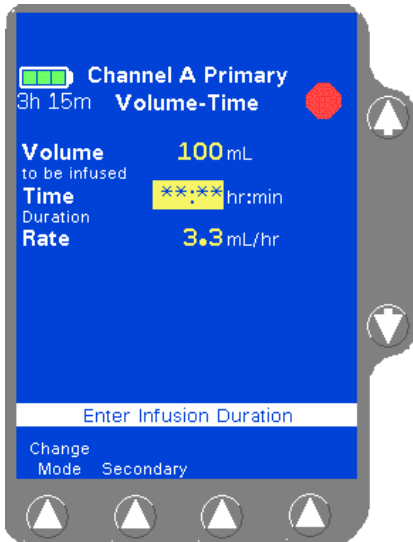

Figure 4-32 Time Duration Field Highlighted

Note:
Time Duration
Greater than
99:59

The time duration must be less than or equal to 99:59. If a time greater than 99:59 is entered, ***:*** is displayed and highlighted in the Time Duration field (Figure 4-32). The infusion cannot be confirmed or started.

If the **START** key is pressed, an **Unconfirmed Primary Program** alarm occurs and a message is displayed on the prompt line. To clear the alarm and start the infusion, enter a time duration less than or equal to 99:59.

6. Verify that the values are appropriate. After the time duration is programmed, the **Volume to be infused** or **Rate** can be changed. The pump then calculates the new time duration automatically.

Note: An optional label may also be selected. See “Selecting a Label” on page 4-24 for details.

7. Press the **Confirm Primary** soft key.

Note: If the **START** key is pressed before pressing the **Confirm Primary** soft key, an **Unconfirmed Primary Program** alarm occurs and a message is displayed on the prompt line.

8. Press the **START** key to start the infusion.

If a secondary infusion has been programmed but not started, or if any values remain from a stopped secondary infusion, a pop-up appears (Figure 4-26 on page 4-23) warning that a primary infusion is about to start when a secondary infusion has been programmed. Press the **Done** soft key to clear the warning and do one of the following:

- Press the **START** key again to start the primary infusion, or
- Press the **Secondary** soft key to access the secondary infusion programming screen. Clear or confirm the secondary infusion program as needed. For more information about secondary infusions, see “Secondary Infusions,” 4-48.

Note: Clearing the values in the secondary program prevents the warning pop-up from reappearing when unintended.

Unintended Secondary Infusion Warnings

Programming a Primary COLLEAGUE GUARDIAN Infusion (Rate-Volume)

- From the Main Display, access the Programming screen:

<p>For single channel pumps:</p> <p>press the Primary soft key or the Rate or Volume keys.</p>	<p>For triple channel pumps:</p> <p>press the desired Channel Select key.</p>
----------------------------------------------------------------------------------------------------------------------------	---------------------------------------------------------------------------------------------

- From the Programming screen, press the **Colleague Guardian** soft key (Figure 4-33).

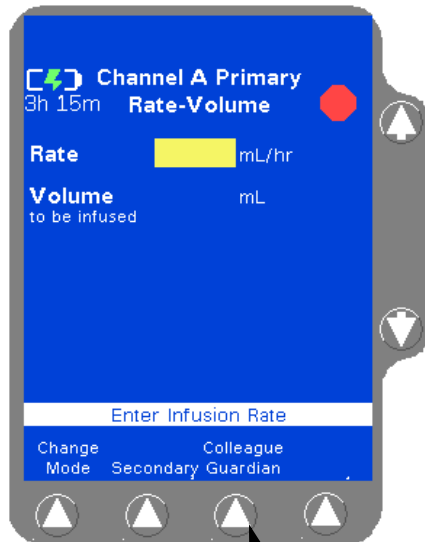

Figure 4-33 Colleague Guardian Soft Key

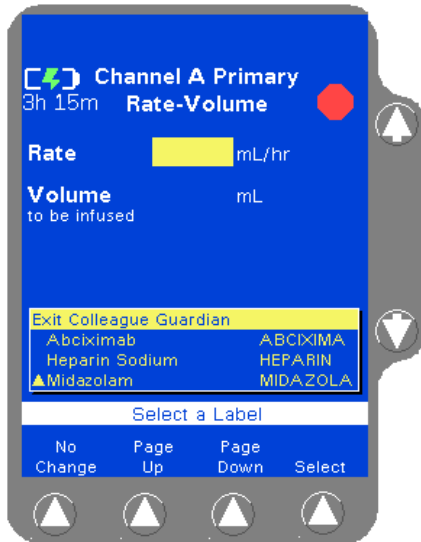

Figure 4-34 COLLEAGUE GUARDIAN Label List

- Use the $\uparrow\downarrow$ keys (and **Page Up/Page Down** soft keys if necessary) to highlight the desired label, then press the **Select** soft key.

The labels for which COLLEAGUE GUARDIAN limits have been defined are displayed in a pop-up window (Figure 4-34). A yellow triangle beside the label indicates that the standard concentration can be edited if clinically necessary.

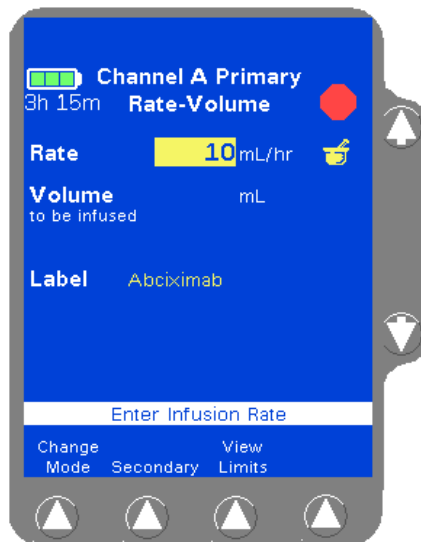

Figure 4-35 COLLEAGUE GUARDIAN Programming Screen—Rate-Volume Label

The programming mode changes to the mode configured for the selected label, and the **Rate** field is filled with the configured value (Figure 4-35).



Figure 4-36 COLLEAGUE GUARDIAN Limits Display Pop-up

4. (Optional) To view a pop-up window (Figure 4-36) showing the limits programmed for the label, highlight the **Rate** field, then press the **View Limits** soft key. Press the **Done** soft key to close the pop-up and continue.
5. (Optional) To modify the rate if clinically appropriate, use the \uparrow key to highlight the **Rate** field, then use the numeric keypad to enter a different rate.
6. Use the \downarrow key to highlight the **The Volume To Be Infused** field.
7. Enter the desired volume using the numeric keypad.

Note: If a rate is entered that is outside the rate limits of the pump or the current PERSONALITY feature set, **High** or **Low** is displayed in the Rate field. Reprogram so that the rate is within the limits.

8. Verify that the values are appropriate and:
 - that pump programming matches the label on the source container and the physician's order
 - that the loaded administration set is connected to the correct source container and administration route for the programmed infusion
9. Then press the **Confirm Primary** soft key.

If the values entered result in a dose that is outside the COLLEAGUE GUARDIAN rate limits, a Limits Warning pop-up is displayed, showing the flow rate entered and the defined rate limits (Figure 4-37). If this occurs, do one of the following:

- Press **Cancel Rate** (\downarrow key) to cancel the rate and return to the programming screen, then enter a rate that is within the rate limits.
- If the clinical decision is to proceed with the override of the COLLEAGUE GUARDIAN limits, press **Accept Rate** (\uparrow key) to accept the out-of limits flow rate and continue with the infusion as programmed.

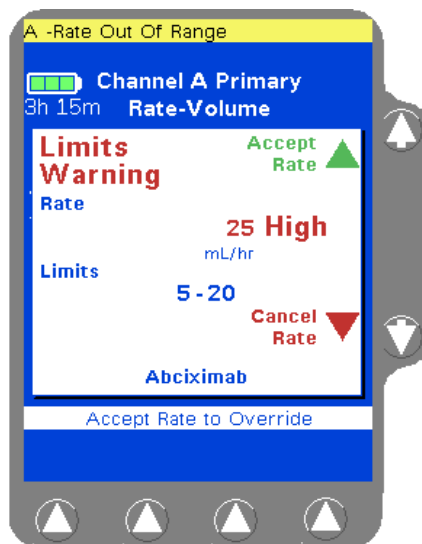
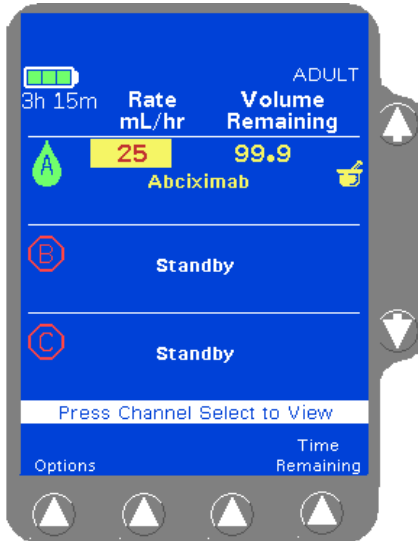

Figure 4-37 Limits Warning Pop-up



**Figure 4-38 Infusion with
COLLEAGUE GUARDIAN Limit
Override**

10. Press the **START** key to begin the infusion. COLLEAGUE GUARDIAN infusions are indicated by the mortar and pestle icon next to the label on the Main Display screen (Figure 4-38)

Note: Overriding COLLEAGUE GUARDIAN Limits

If the clinical decision was to override the COLLEAGUE GUARDIAN limits, the rate is displayed in red on a yellow highlight indicating that the programmed dose is outside of the COLLEAGUE GUARDIAN limits.

If a secondary infusion has been programmed but not started, or if any values remain from a stopped secondary infusion, a pop-up appears (Figure 4-26 on page 4-23) warning that a primary infusion is about to start when a secondary infusion has been programmed. Press the **Done** soft key to clear the warning and do one of the following:

- Press the **START** key again to start the primary infusion, or
- Press the **Secondary** soft key to access the secondary infusion programming screen. Clear or confirm the secondary infusion program as needed. For more information about secondary infusions, see “Secondary Infusions,” 4-48.

Note: Unintended Secondary Infusion Warnings

Clearing the values in the secondary program prevents the warning pop-up from reappearing when unintended.

Programming a Primary COLLEAGUE GUARDIAN Infusion (Non-Weight-Based)

- From the Main Display, access the Programming screen:

<p>For single channel pumps:</p> <p>press the Primary soft key or the Rate or Volume keys.</p>	<p>For triple channel pumps:</p> <p>press the desired Channel Select key.</p>
----------------------------------------------------------------------------------------------------------------------------	---------------------------------------------------------------------------------------------

- From the Programming screen, press the **Colleague Guardian** soft key.

The labels for which COLLEAGUE GUARDIAN limits have been configured are displayed in a pop-up window (Figure 4-39). A yellow triangle beside the label indicates that the standard concentration can be edited if clinically necessary.

- Use the $\uparrow\downarrow$ keys (and **Page Up/Page Down** soft keys if necessary) to highlight the desired label, then press the **Select** soft key.

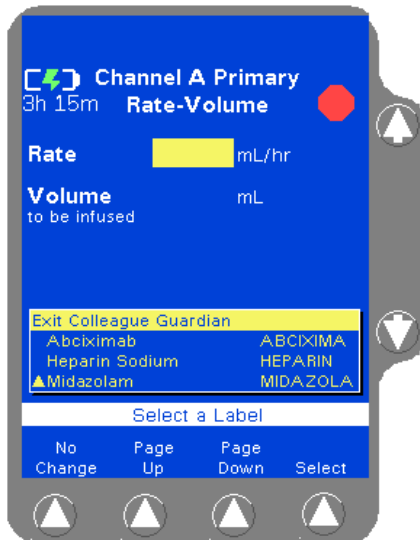

Figure 4-39 COLLEAGUE GUARDIAN Label List

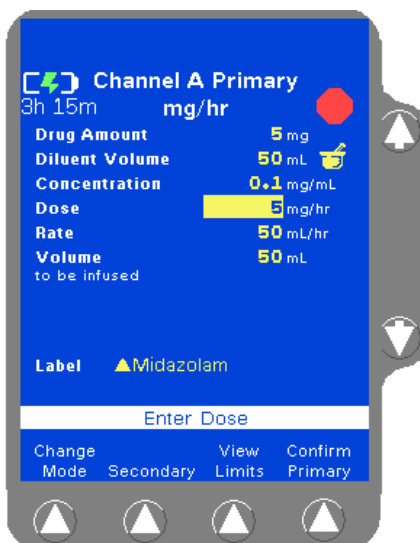

Figure 4-40 COLLEAGUE GUARDIAN Programming Screen—Non-Weight-Based Label

The programming mode changes to the mode configured for the selected label, and the **Drug Amount**, **Diluent Volume**, and **Concentration** fields are filled with the defined values. The **Volume To Be Infused** field is filled with the standard Diluent Volume (Figure 4-40).

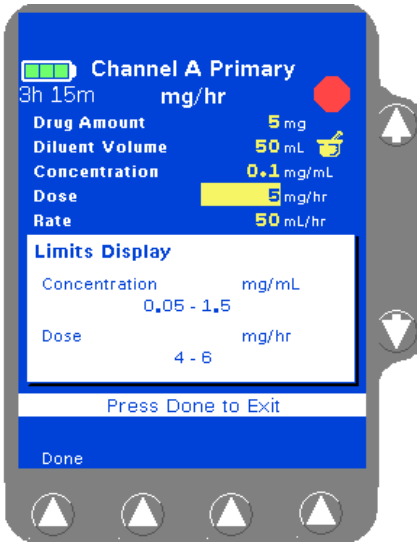

Figure 4-41 COLLEAGUE GUARDIAN Limits Display Pop-up

4. (Optional) To view a pop-up window (Figure 4-41) showing the limits programmed for the label, highlight the **Concentration** or **Dose** fields, then press the **View Limits** soft key. Press the **Done** soft key to close the pop-up and continue. Concentration limits cannot be overridden.
5. (Optional) If the label is set up to allow non-standard concentration programming, the drug amount, diluent volume, and concentration can be changed by using the $\uparrow\downarrow$ keys to highlight the appropriate field and entering new values using the numeric keypad.
6. Use the \downarrow key to highlight the **Dose** field.
7. Enter the desired dose (or change the default dose, if clinically appropriate) using the numeric keypad. The pump displays the dose and calculated flow rate.

Note: If a dose is entered that results in a rate outside the rate limits of the current PERSONALITY feature set, **High** or **Low** is displayed in the **Rate** field. Reprogram so that the rate is within the limits.

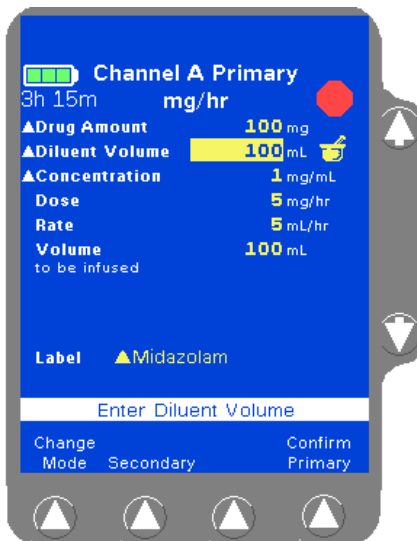

Figure 4-42 Non-Standard COLLEAGUE GUARDIAN Programming—Non-Weight-Based

- If values are changed so that the resulting drug amount, diluent volume, or concentration differs from the defined values, the changed values are indicated by white triangles beside them (Figure 4-42).
8. Verify that all values are appropriate and:
 - that pump programming matches the label on the source container and the physician's order
 - that the loaded administration set is connected to the correct source container and administration route for the programmed infusion

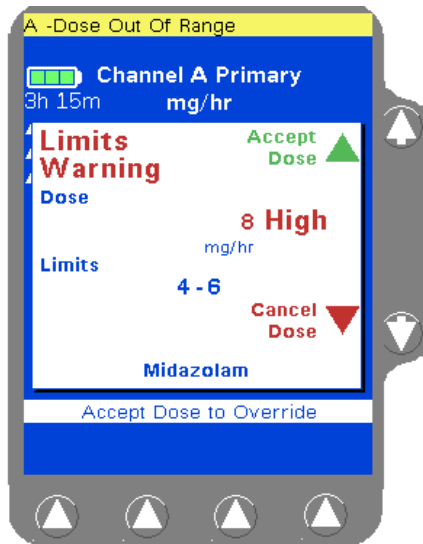

Figure 4-43 Limits Warning Pop-up

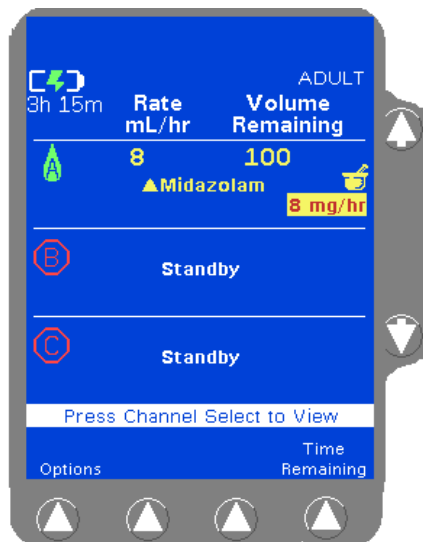

Figure 4-44 Infusion with COLLEAGUE GUARDIAN Limit Override

9. Press the **Confirm Primary** soft key.

If the values entered result in a dose that is outside the COLLEAGUE GUARDIAN dose limits, a Limits Warning pop-up is displayed, showing the calculated dose and the dose limits (Figure 4-43). If this occurs, do one of the following:

- Press **Cancel Dose** (⇩ key) to cancel the dose and return to the programming screen, then enter a dose that is within the preset limits.
- If the clinical decision is to proceed with the override of the COLLEAGUE GUARDIAN limits, press **Accept Dose** (⇧ key) to accept the out-of limits dose and continue with the infusion as programmed.

10. Press the **START** key to begin the infusion. COLLEAGUE GUARDIAN infusions are indicated by the mortar and pestle icon next to the channel on the Main Display screen.

A yellow triangle is displayed beside the label name if the drug amount, diluent, or concentration was changed to deviate from the standard COLLEAGUE GUARDIAN settings.

Note: If the clinical decision was to override the COLLEAGUE GUARDIAN limits, the dose and programming mode are displayed in red on a yellow highlight (Figure 4-44) indicating that the programmed dose is outside of the COLLEAGUE GUARDIAN limits.

If a secondary infusion has been programmed but not started, or if any values remain from a stopped secondary infusion, a pop-up appears (Figure 4-26 on page 4-23) warning that a primary infusion is about to start when a secondary infusion has been programmed. Press the **Done** soft key to clear the warning and do one of the following:

- Press the **START** key again to start the primary infusion, or

- Press the **Secondary** soft key to access the secondary infusion programming screen. Clear or confirm the secondary infusion program as needed. For more information about secondary infusions, see “Secondary Infusions,” 4-48.

Note: Clearing the values in the secondary program prevents the warning pop-up from reappearing when unintended. Secondary Infusion Warnings

Programming a Primary COLLEAGUE GUARDIAN Infusion (Weight-Based)

1. From the Main Display, access the Programming screen:

For single channel pumps:	For triple channel pumps:
press the Primary soft key or the Rate or Volume keys.	press the desired Channel Select key.

2. From the Programming screen, press the **Colleague Guardian** soft key.

The labels for which COLLEAGUE GUARDIAN limits have been configured are displayed in a pop-up window (Figure 4-45). A yellow triangle beside the label indicates that the standard concentration can be edited if clinically necessary

3. Use the $\uparrow\downarrow$ keys (and **Page Up/Page Down** soft keys if necessary) to highlight the desired label, then press the **Select** soft key.

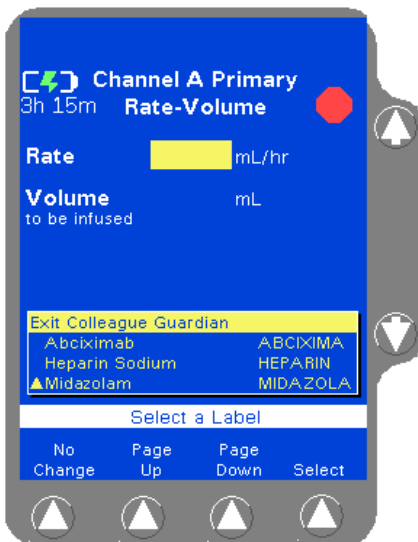

Figure 4-45 COLLEAGUE GUARDIAN Label List



Figure 4-46 COLLEAGUE GUARDIAN Programming Screen—Weight-Based Label

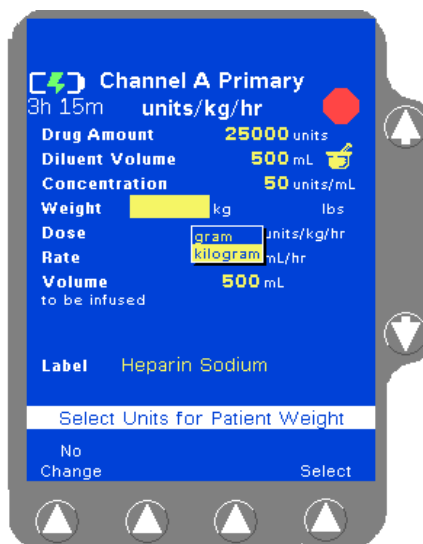

Figure 4-47 Weight Unit Pop-up

The programming mode changes to the mode configured for the selected label, and the **Drug Amount**, **Diluent Volume**, and **Concentration** fields are filled with the defined values. The **Weight** field is highlighted (Figure 4-46). If a default dose has been configured, it appears in the **Dose** field.

4. For small patients, weight can be entered in grams (or ounces) if appropriate. To change weight units, highlight the **Weight** field, press the **Units** soft key to display the weight units list (Figure 4-47), highlight the desired weight unit, then press the **Select** soft key.
5. Enter patient weight using the numeric keypad.

Depending on how the pump has been configured at the facility, the **kg** or **lbs** field may not be available for data entry. Fields not available for data entry appear as shaded.

The pump calculates and displays the values for the remaining fields based on the entered patient weight (Figure 4-48).



Figure 4-48 Calculated Values

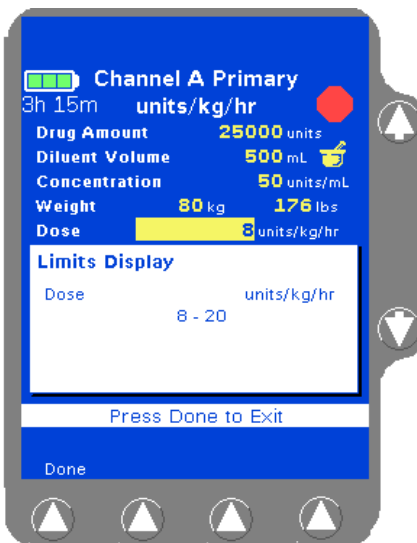

Figure 4-49 View Limits Pop-up

6. Use the \downarrow key to highlight the **Dose** field.
7. Enter the desired dose (or change the default dose, if clinically appropriate) using the numeric keypad. The pump displays the dose and calculated flow rate.

8. (Optional) To view a pop-up window (Figure 4-49) showing the limits programmed for the label, highlight the **Concentration** or **Dose** fields, then press the **View Limits** soft key. Press the **Done** soft key to close the pop-up and continue. Concentration limits cannot be overridden.
9. (Optional) If the label is set up to allow non-standard concentration programming, the drug amount, diluent volume, and concentration can be changed by using the \uparrow \downarrow keys to highlight the appropriate field and entering new values using the numeric keypad.

Note: If the entries result in a rate outside the rate limits of the current PERSONALITY feature set, **High** or **Low** is displayed in the Rate field. Reprogram other values so that the rate is within the limits.

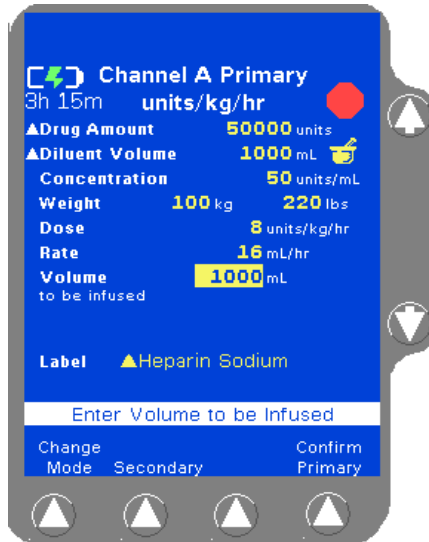

Figure 4-50 Non-Standard COLLEAGUE GUARDIAN Programming—Weight-Based

If values are changed so that the resulting drug amount, diluent volume, or concentration is non-standard, the changed values are indicated by white triangles beside them (Figure 4-50).

10. Verify that all values are appropriate and:
 - that pump programming matches the label on the source container and the physician’s order
 - that the loaded administration set is connected to the correct source container and administration route for the programmed infusion
11. Press the **Confirm Primary** soft key.

If the dose entered is outside the COLLEAGUE GUARDIAN dose limits, a Limits Warning pop-up is displayed, showing the calculated dose and the dose limits. If this occurs, do one of the following:

- Press **Cancel Dose** (⇩ key) to cancel the dose and return to the programming screen, then enter a dose that is within the preset limits.
- If the clinical decision is to proceed with the override of the COLLEAGUE GUARDIAN limits, press **Accept Dose** (⇧ key) to accept the out-of limits dose and continue with the infusion as programmed.

Note:
Weight Differences (Triple Channel Pumps Only)

The pump will detect weight differences and display a pop-up window for the following:

- If a patient weight is entered on one channel and a different patient weight is entered on another channel.
- If a patient weight is entered on one channel and the same patient weight is entered on another channel using different units (lbs on one channel and kg on the other for example), and the units conversion causes the weights to appear slightly different on the display.

The pop-up window will ask to confirm the difference. If the difference was not intentional, the weight can be modified on the programming screen.

Press the **Confirm** soft key if the weight difference is acceptable; if not, press the appropriate **Channel Select** key to return to the programming screen and change the weight.

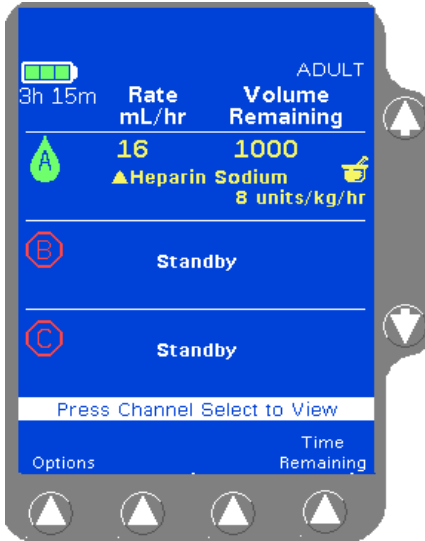

Figure 4-51 Main Display with Non-Standard Concentration

12. Press the **START** key to begin the infusion. COLLEAGUE GUARDIAN infusions are indicated by a mortar and pestle icon next to the channel on the Main Display screen

A yellow triangle is displayed beside the label name if the drug amount, diluent, or concentration was changed to deviate from the standard COLLEAGUE GUARDIAN settings.

Note: If the clinical decision was to override the COLLEAGUE GUARDIAN limits, the dose and programming mode are displayed in red on a yellow highlight, indicating that the programmed dose is outside of the COLLEAGUE GUARDIAN limits.

If a secondary infusion has been programmed but not started, or if any values remain from a stopped secondary infusion, a pop-up appears (Figure 4-26 on page 4-23) warning that a primary infusion is about to start when a secondary infusion has been programmed. Press the **Done** soft key to clear the warning and do one of the following:

- Press the **START** key again to start the primary infusion, or
- Press the **Secondary** soft key to access the secondary infusion programming screen. Clear or confirm the secondary infusion program as needed. For more information about secondary infusions, see “Secondary Infusions,” 4-48.

Note: Clearing the values in the secondary program prevents the warning pop-up from reappearing when unintended.

Unintended Secondary Infusion Warnings

Programming a Primary Dose Mode Infusion (Non-Weight Based)

1. From the Main Display, access the Programming screen:

<p>For single channel pumps:</p> <p>press the Primary soft key or the Rate or Volume keys.</p>	<p>For triple channel pumps:</p> <p>press the desired Channel Select key.</p>
----------------------------------------------------------------------------------------------------------------------------	---------------------------------------------------------------------------------------------

2. From the Programming screen, press the **Change Mode** soft key. The Programming Modes menu is displayed (Figure 4-52).
3. Use the $\uparrow\downarrow$ and/or **Page Up, Page Down** soft keys to highlight the appropriate dose formula selection, if configured. Some or all of the following dose modes may be available depending on pump configuration at the facility:
 - Colleague Guardian
 - mg/hr
 - mg/min
 - mcg/hr
 - units/hr
 - mcg/min
 - mEq/hr

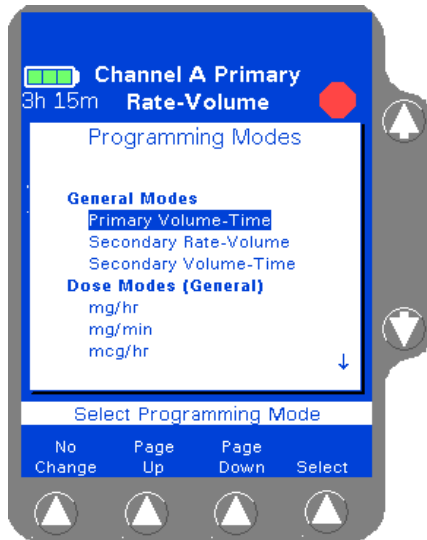

Figure 4-52 Programming Modes

4. Press the **Select** soft key to display the Dose Programming screen (Figure 4-53).

Any dose parameters retained in memory are displayed.

- To use the existing parameters, press the **Confirm Primary** soft key.
- To clear the parameters, enter new values or press the **CLR** key for each value.

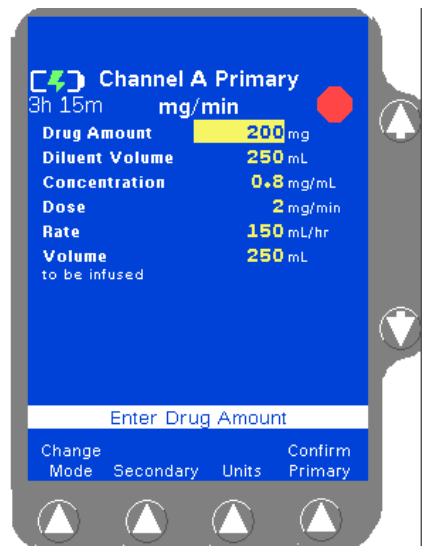

Figure 4-53 Dose Programming Screen

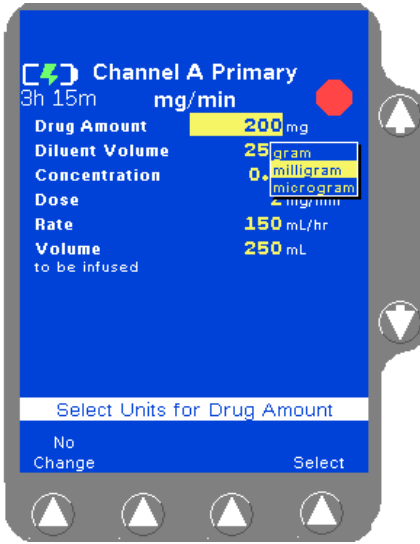

Figure 4-54 Units Change List

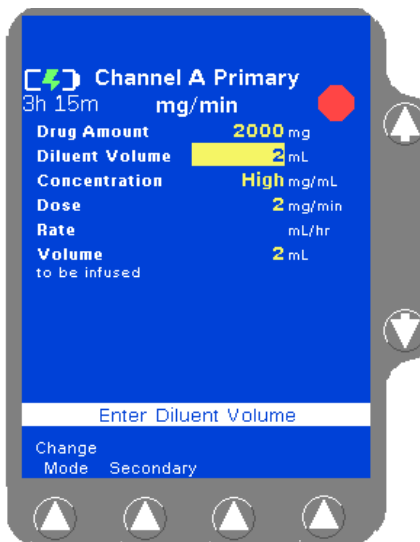

Figure 4-55 Value High Prompt

5. Check the units of measure displayed for the **Drug Amount**. To enter the drug amount in units other than the one displayed:
 - 5.1 Press the **Units** soft key to display the Units Change list (Figure 4-54).
 - 5.2 Use the $\uparrow\downarrow$ keys to highlight the desired units.
 - 5.3 Press the **Select** soft key to change to the highlighted units.
6. Enter the desired **Drug Amount** using the numeric keypad and press the \downarrow key to highlight the **Diluent Volume** field.

7. Enter the desired Diluent Volume using the numeric keypad.

Note:
Concentration Too High

The pump calculates the concentration as diluent volume is entered. In Figure 4-55, the concentration is too high because the pump is calculating as the numbers are being entered. This **High** condition is cleared after the rest of the digits are entered and the pump recalculates the concentration.

8. Use the \downarrow key to highlight the **Dose** field.
9. Enter the desired dose using the numeric keypad.

If desired, the **Dose** field can be bypassed by using the \downarrow key and entering the **Rate** value first. The pump then calculates the Dose.

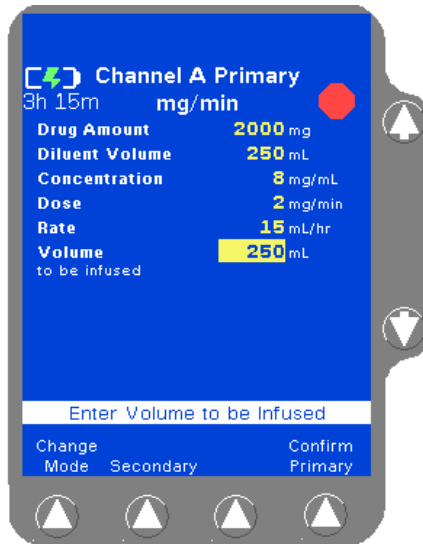

Figure 4-56 Enter Volume to be Infused

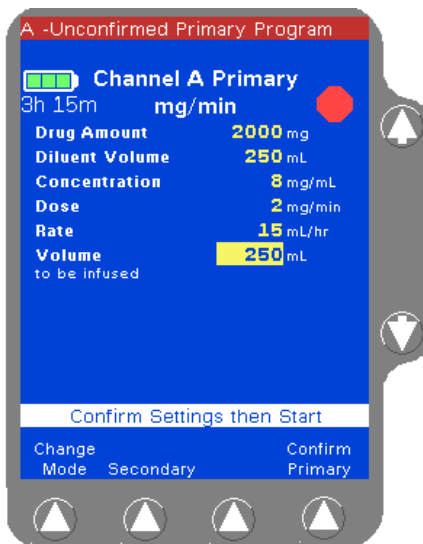

Figure 4-57 Unconfirmed Primary Program

10. Use the ↓ key to highlight the **Volume to be infused** field (Figure 4-56).

The **Volume to be infused** field defaults to the Diluent Volume. The Volume to be infused may be less than the Diluent Volume, but cannot be greater than the Diluent Volume.

11. If appropriate, change the **Volume to be infused** value.

Note: An optional label may also be selected. See “Selecting a Label” on page 4-24 for details.

12. Verify that all values are appropriate and:

- that pump programming matches the label on the source container and the physician’s order
- that the loaded administration set is connected to the correct source container and administration route for the programmed infusion

13. Press the **Confirm Primary** soft key.

Note: If the **START** key is pressed before pressing the **Confirm Primary** soft key to verify the parameters, an **Unconfirmed Primary Program** alarm occurs and a message is displayed on the prompt line (Figure 4-57).



Figure 4-58 Main Display

14. Press the appropriate **START** key to begin the infusion. The Main Display screen shows the rate, volume remaining, and the dose (Figure 4-58).

If a secondary infusion has been programmed but not started, or if any values remain from a stopped secondary infusion, a pop-up appears (Figure 4-26 on page 4-23) warning that a primary infusion is about to start when a secondary infusion has been programmed. Press the **Done** soft key to clear the warning and do one of the following:

- Press the **START** key again to start the primary infusion, or
- Press the **Secondary** soft key to access the secondary infusion programming screen. Clear or confirm the secondary infusion program as needed. For more information about secondary infusions, see “Secondary Infusions,” 4-48.

Note: Clearing the values in the secondary program prevents the warning pop-up from reappearing when unintended.
Unintended Secondary Infusion Warnings

Programming a Primary Dose Mode Infusion (Weight-Based)

- From the Main Display, access the Programming screen:

<p>For single channel pumps:</p> <p>press the Primary soft key or the Rate or Volume keys.</p>	<p>For triple channel pumps:</p> <p>press the desired Channel Select key.</p>
----------------------------------------------------------------------------------------------------------------------------	---------------------------------------------------------------------------------------------

- From the Programming screen, press the **Change Mode** soft key. The Programming Modes menu is displayed (Figure 4-59).

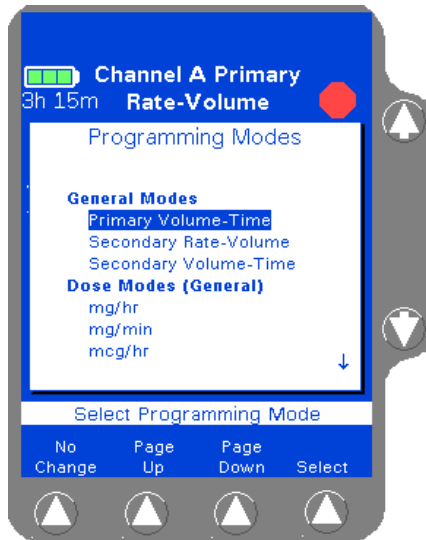

Figure 4-59 Programming Modes

- Use the $\uparrow\downarrow$ and/or **Page Up**, **Page Down** soft keys to highlight the appropriate dose mode selection (Figure 4-60). Some or all of the following dose modes may be available depending on pump configuration at the facility:

- mcg/kg/min
- mg/kg/hr
- mEq/kg/hr
- mg/kg/min
- mcg/kg/hr
- units/kg/hr

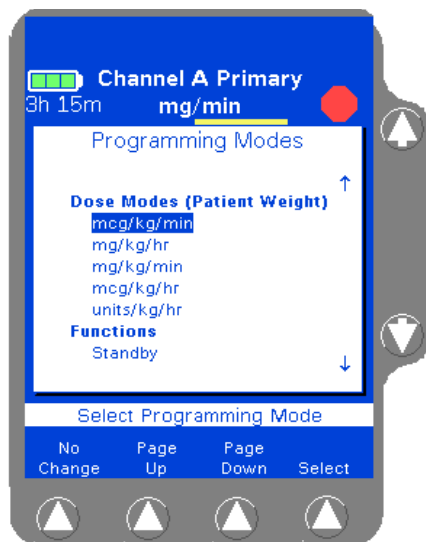

Figure 4-60 Weight-Based Dose Programming Modes



Figure 4-61 Dose Programming Screen



Figure 4-62 Units Change List

4. Press the **Select** soft key to display the Dose Programming screen (Figure 4-61), which allows entry of patient weight.

Any dose parameters retained in memory are displayed.

- To use the existing parameters, press the **Confirm Primary** soft key.
- To clear the parameters, enter new values or press the **CLR** key for each value.

5. Check the units of measure displayed for the **Drug Amount**. To enter the drug amount in units other than the one displayed:
 - 5.1 Press the **Units** soft key to display the Units Change list (Figure 4-62).
 - 5.2 Use the $\uparrow\downarrow$ keys to highlight the desired units.
 - 5.3 Press the **Select** soft key to change to the highlighted units.
6. Enter the desired **Drug Amount** using the numeric keypad and press the \downarrow key to highlight the **Diluent Volume** field.

- Enter the desired Diluent Volume using the numeric keypad.

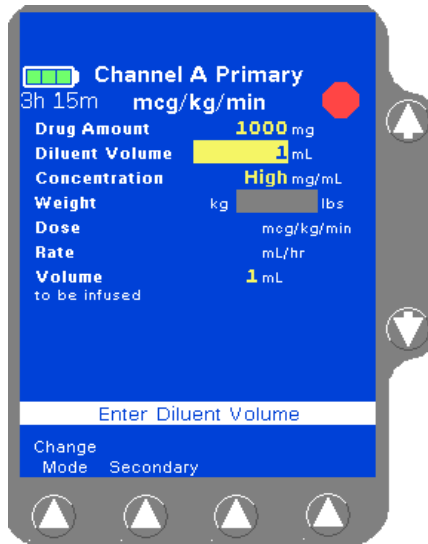

Figure 4-63 Value High Prompt

Note:
Concentration Too High

The pump calculates the concentration as diluent volume is entered. In Figure 4-63, the concentration is too high because the pump is calculating as the numbers are being entered. This **High** condition is cleared after the rest of the digits are entered and the pump recalculates the concentration.

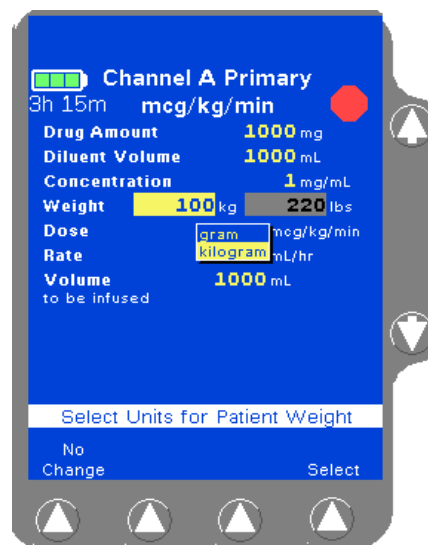

Figure 4-64 Enter Weight

- Highlight the **Weight** field and enter the patient's weight using the numeric keypad (Figure 4-64). Depending on how the pump has been configured, the **kg** or **lbs** field may not be available for data entry.

Fields not available for data entry appear as shaded.

- For small patients, weight can be entered in grams (or ounces) if appropriate. Highlight the **Weight** field, press the **Units** soft key to display the weight units list (Figure 4-64), highlight the desired weight unit, then press the **Select** soft key.



Figure 4-65 Example of Out-of-Range Weights

- If the weight is outside the allowed weight limits, the word **Low** or **High** is displayed (Figure 4-65). Select a weight within limits.

Note:
Weight Limits

The pump is capable of accepting patient weights within the range 0.2 to 600 kg (0.44 to 1322 lb). However, the pump's current PERSONALITY feature set may have been configured with a narrower weight range. Use the **Options** soft key on the Main Display to view the settings for the current PERSONALITY feature set if desired.

9. Use the \downarrow key to highlight the **Dose** field.

10. Enter the desired dose using the numeric keypad.

If desired, the **Dose** field can be bypassed by using the \downarrow key and entering the **Rate** value first. The pump then calculates the Dose.

11. Use the \downarrow key to highlight the **Volume to be infused** field.

The **Volume to be infused** field defaults to the Diluent Volume. The Volume to be infused may be less than the Diluent Volume, but cannot be greater than the Diluent Volume.

12. If appropriate, change the **Volume to be infused** value.

Note: An optional label may also be selected. See "Selecting Optional Labels a Label" on page 4-24 for details.

13. Verify that all values are appropriate and:
 - that pump programming matches the label on the source container and the physician's order
 - that the loaded administration set is connected to the correct source container and administration route for the programmed infusion

14. Press the **Confirm Primary** soft key.

Note: If the **START** key is pressed before pressing the **Confirm Primary** soft key to verify the parameters, an **Unconfirmed Primary Program** alarm occurs and a message is displayed on the prompt line (Figure 4-66).



Figure 4-66 Unconfirmed Primary Program



Figure 4-67 Weight Difference Confirmation Pop-up (Triple Channel Pumps Only)

Note: Weight Differences (Triple Channel Pumps Only)

The pump will detect weight differences and display a pop-up window for the following:

- If a patient weight is entered on one channel and a different patient weight is entered on another channel.
- If a patient weight is entered on one channel and the same patient weight is entered on another channel using different units (lbs on one channel and kg on the other for example), and the units conversion causes the weights to appear slightly different on the display.

The pop-up window (Figure 4-67) will ask to confirm the difference. If the difference was not intentional, the weight can be modified on the programming screen.

Press the **Confirm** soft key if the weight difference is acceptable; if not, press the appropriate **Channel Select** soft key to return to the programming screen and change the weight.

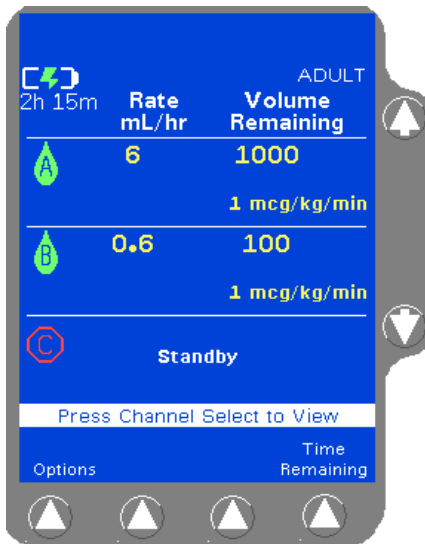

Figure 4-68 Main Display

15. Press the **START** key to begin the infusion. The Main Display screen shows the rate, volume remaining, and the dose (Figure 4-68).

If a secondary infusion has been programmed but not started, or if any values remain from a stopped secondary infusion, a pop-up appears (Figure 4-26 on page 4-23) warning that a primary infusion is about to start when a secondary infusion has been programmed. Press the **Done** soft key to clear the warning and do one of the following:

- Press the **START** key again to start the primary infusion, or
- Press the **Secondary** soft key to access the secondary infusion programming screen. Clear or confirm the secondary infusion program as needed. For more information about secondary infusions, see “Secondary Infusions,” 4-48.

Note: Clearing the values in the secondary program prevents the warning pop-up from reappearing when unintended. Secondary Infusion Warnings

Secondary Infusions

This optional programming function allows the pump to deliver fluid from a second source container at a rate and volume that is independent of the primary infusion. When the secondary infusion is complete, the pump automatically switches to the programmed primary rate if a confirmed primary infusion exists.

Note: A secondary infusion can be programmed while a primary infusion is running. A **Programming Secondary** alert message will be displayed with an audible alert tone.

! WARNING !

When using primary administration sets with check valves and secondary administration sets for secondary infusions, factors including but not limited to programmed infusion rates, fluid viscosity, source containers (type and size), and head height differences may influence system performance. Flow rates greater than 350 mL/hr may cause fluid to be siphoned from the primary source container during infusions, causing concurrent flow.

! WARNING !

Use only CONTINU-FLO standard administration sets equipped with keyed slide clamps and labeled as COLLEAGUE pump compatible or denoted with an “s” in the product code as the primary fluid line when administering a secondary medication/solution. See “Recommended Administration Sets,” 4-15. Carefully follow the directions on the primary and secondary administration set labels.

When using the secondary infusion feature ensure:

- the medication/solution in the secondary source container is compatible with the medication/solution in the primary source container.
- the secondary administration set is connected to the appropriate injection site on the CONTINU-FLO administration set.
- the interruption of the primary infusion is clinically appropriate for the duration of the secondary infusion.
- the infusion runs from a secondary source container and not from a primary container.

! WARNING !

Failure to properly lower the primary container by fully extending the hanger increases the potential for concurrent flow. Concurrent flow leads to over-infusion of the primary infusion and under-infusion of the secondary infusion.

! WARNING !

Always read and follow the instructions which accompany the source container and administration sets you are using. Carefully follow any label copy instructions for loading, removing, and reloading the set, as well as the recommended set change interval. For optimal pump performance, set use should not exceed the change interval shown on the set's label copy or 72 hours, whichever is less.

! WARNING !

COLLEAGUE pumps do not support same-bag loading dose or bolus as it may lead to an over-infusion, under-infusion, or interruption of therapy.

! WARNING !

Failure to open the roller clamp on a secondary set when starting a secondary infusion will cause a delay of the secondary infusion and an over-infusion of the primary infusion.

Setting up a Secondary Infusion

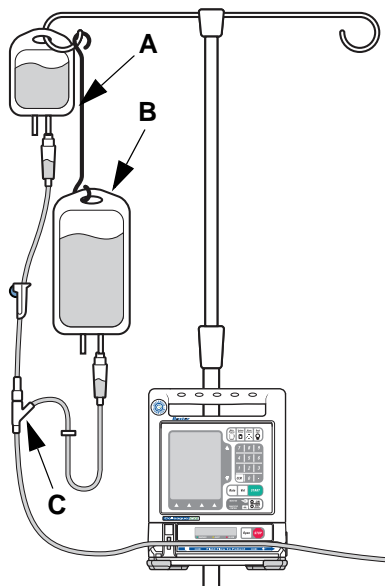

Figure 4-69 Secondary Infusion Setup

Figure 4-69 shows a complete setup for a secondary infusion.

1. Spike the solution container(s) and prime the administration set(s) following the manufacturer's directions for use.
2. Lower the primary container (Figure 4-69B) using the hanger (Figure 4-69A) provided with the secondary administration set. Ensure the hanger is fully extended.

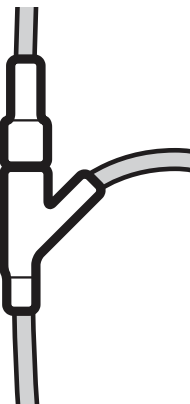

Figure 4-70 Y-Site Above the Pump

3. Attach the secondary medication to the y-site above the pump (Figure 4-69C, detail in Figure 4-70), ensuring the secondary administration set roller clamp is closed.
4. If a primary infusion is not currently running, load the CONTINU-FLO administration set into the desired pump channel as described in "Loading the Administration Set," 4-16.
5. Program the secondary infusion as needed:
 - "Programming a Secondary Rate-Volume Infusion," 4-50, or
 - "Programming a Secondary Volume-Time Infusion," 4-52.

Programming a Secondary Rate-Volume Infusion

Note: Perform steps 1 through 5 of “Setting up a Secondary Secondary Set Up” 4-49 prior to programming a secondary infusion.

6. From the Main Display screen:

For single channel pumps:	For triple channel pumps:
press the Secondary soft key.	press the desired Channel Select key, then press the Secondary soft key.

The Secondary Rate-Volume Programming screen is displayed, including the secondary icon (Figure 4-71). The **Rate** field is highlighted.

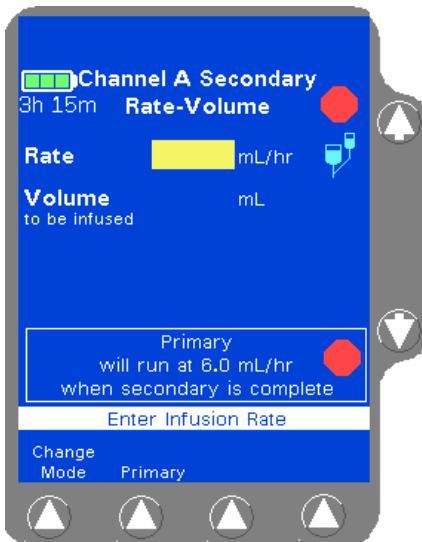

Figure 4-71 Secondary Programming Screen

! WARNING ! There may be periods of no flow for flow rates less than or equal to 1mL/hr.

- Enter the secondary flow rate using the numeric keypad.
- Press the **Vol** key or use the $\uparrow\downarrow$ keys to highlight the **Volume to be infused** field.

! WARNING ! Do not enter a **Volume to be infused** greater than the amount of fluid available in the container.

- Enter the **Volume to be infused** using the keypad.

Note: Programming Tips If an incorrect value is entered during programming, press the **CLR** key to clear the field, then enter the correct value.

If program values that exceed the allowable range available are programmed, **High** or **Low** will be displayed and an **Out of Range** alarm will occur when the **START** key is pressed.

Note: Time Duration Greater than 99:59 If the rate and volume entered results in a time duration exceeding 99:59, the time duration will be displayed as **:**. Upon starting the infusion, the pump will properly track the time remaining, although it will continue to display **:**. until 99:59 is reached. Then the actual time remaining will display.

Note: An optional label may also be selected. See “Selecting Optional Labels a Label” on page 4-24 for details.

10. When all infusion parameters have been entered, verify that:
 - pump programming matches the label on the source container and the physician’s order
 - the loaded administration set is connected to the correct source container and administration route for the programmed infusion

11. Press the **Confirm Secondary** soft key.

Note: If the **START** key is pressed before pressing the **Confirm Secondary** soft key, an **Unconfirmed Secondary Program** alarm occurs and a message is displayed on the prompt line.

12. If the primary administration set has a slide clamp above the pump, close the slide clamp.

13. Open the On/Off roller clamp on the secondary medication/solution set (Figure 4-72) and immediately press the **START** key.

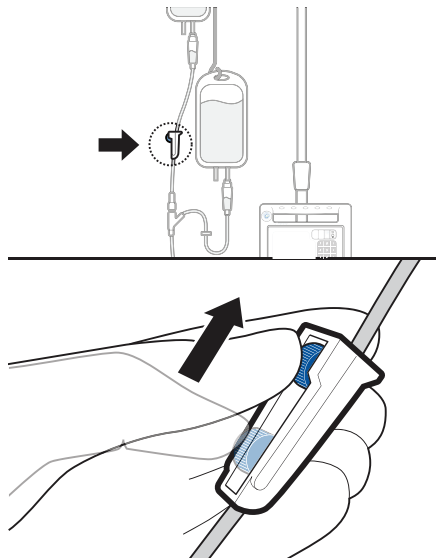
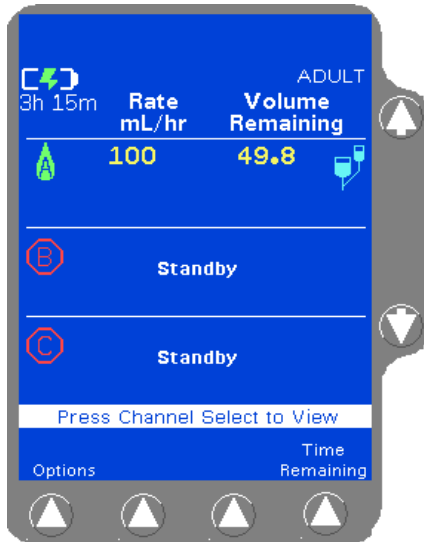

Figure 4-72 On/Off Roller Clamp

Note: If a primary infusion has been programmed but not confirmed, an **Unconfirmed Primary Program** alarm occurs and a message is displayed on the prompt line. The primary infusion must be confirmed before the secondary infusion can be started. Complete the following:

- Press the **Primary** soft key to review the primary infusion program. For more information about primary infusions, see “Primary Infusions,” 4-21.
- Press the **Confirm Primary** soft key.
- Press the **Secondary** soft key to return to the secondary programming screen.
- Press the **START** key again to start the secondary infusion.



**Figure 4-73 Main Display,
Secondary Running**

When the secondary infusion starts, the RUNNING LED on the Pump Module lights and a moving drop icon is shown on the Main Display (Figure 4-73). Confirm that flow is occurring from the secondary solution container by observing drops falling in the secondary drip chamber. Delivery from the primary container will occur when the secondary container empties.

Note: If the primary administration set has a slide clamp above the pump, when the secondary infusion has completed, open the slide clamp above the pump to restart the primary infusion.

After the secondary volume remaining reaches zero, the program automatically reverts to the primary rate or to a KVO (Keep Vein Open) rate if no primary infusion has been programmed.

Programming a Secondary Volume-Time Infusion

Note: Perform steps 1 through 5 of “Setting up a Secondary Infusion,” 4-49 prior to programming a secondary infusion.

6. From the Main Display screen:

<p>For single channel pumps: press the Secondary soft key.</p>	<p>For triple channel pumps: press the desired Channel Select key, then press the Secondary soft key.</p>
----------------------------------------------------------------------------------	------------------------------------------------------------------------------------------------------------------------------------



Figure 4-74 Programming Modes Menu

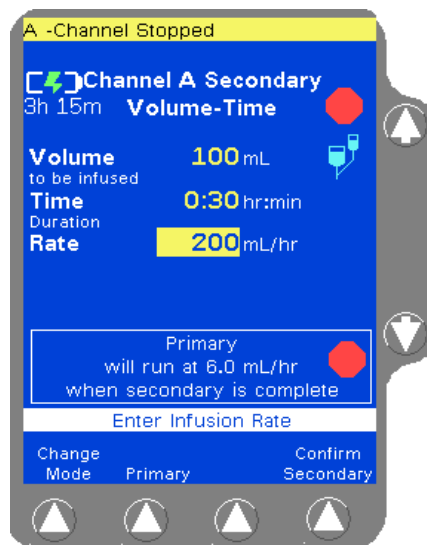

Figure 4-75 Secondary Volume-Time Programming Screen

7. Press the **Change Mode** soft key. The Programming Modes menu is displayed (Figure 4-74).

8. Highlight **Secondary Volume-Time** using the $\uparrow\downarrow$ keys, then press the **Select** soft key. The Secondary Volume-Time Programming screen is displayed (Figure 4-75).

9. Enter the **Volume to be infused** using the keypad.

10. Highlight **Time Duration** using the $\uparrow\downarrow$ keys. Use the keypad to enter the time period for the infusion in hours and minutes. The pump automatically calculates the flow rate.

The pump may round off the calculated rate. If this occurs, the pump then calculates the time duration based on the rounded rate. When the **Confirm Secondary** soft key is pressed, the calculated time is displayed as **Time Remaining** instead of the time duration entered.

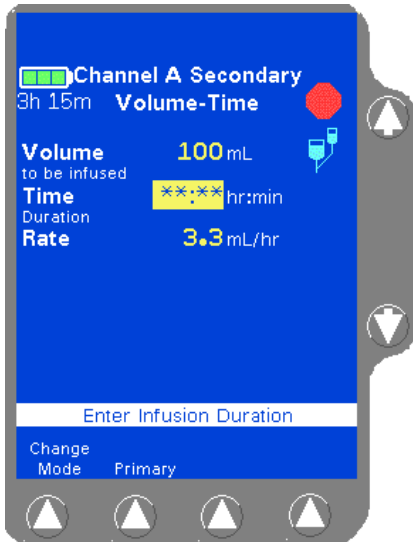

Figure 4-76 Time Duration Field Highlighted

Note:
Time Duration
Greater than
99:59

The time duration must be less than or equal to 99:59. If a time greater than 99:59 is entered, *****:***** is displayed and highlighted in the **Time Duration** field (Figure 4-76). The infusion cannot be confirmed or started.

If the **START** key is pressed, an **Unconfirmed Secondary Program** alarm occurs and a message is displayed on the prompt line. To clear the alarm and start the infusion, enter a time duration less than or equal to 99:59.

11. When all infusion parameters have been entered, verify that:
 - pump programming matches the label on the source container and the physician's order
 - the loaded administration set is connected to the correct source container and administration route for the programmed infusion

After the time duration is programmed, the **Volume to be infused** or **Rate** can be changed. The pump then calculates the new time duration automatically.

Note: Optional Labels An optional label may also be selected. See "Selecting a Label" on page 4-24 for details.

12. Press the **Confirm Secondary** soft key.

Note: Unconfirmed Secondary Program If the **START** key is pressed before pressing the **Confirm Secondary** soft key, an **Unconfirmed Secondary Program** alarm occurs and a message is displayed on the prompt line.

13. If the primary administration set has a slide clamp above the pump, close the slide clamp.

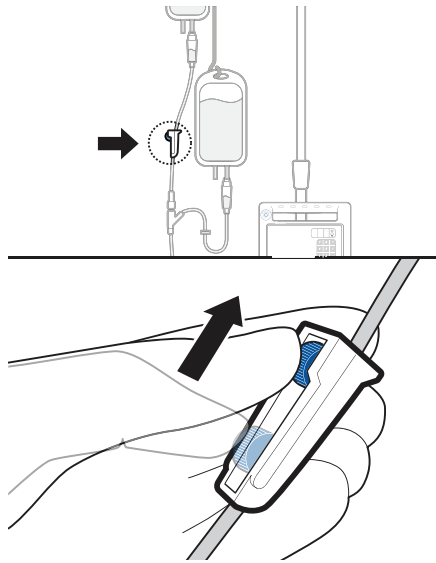

Figure 4-77 On/Off Roller Clamp

14. Open the On/Off roller clamp on the secondary medication/solution set (Figure 4-77) and immediately press the **START** key.

Note:
Unconfirmed
Primary
Program

If a primary infusion has been programmed but not confirmed, an **Unconfirmed Primary Program** alarm occurs and a message is displayed on the prompt line. The primary infusion must be confirmed before the secondary infusion can be started. Complete the following:

- Press the **Primary** soft key to review the primary infusion program. For more information about primary infusions, see "Primary Infusions," 4-21.
- Press the **Confirm Primary** soft key.
- Press the **Secondary** soft key to return to the secondary programming screen.
- Press the **START** key again to start the secondary infusion.

When the secondary infusion starts, the **RUNNING LED** on the Pump Module lights and a moving drop icon is shown on the Main Display (Figure 4-73 on page 4-52). Confirm that flow is occurring from the secondary solution container by observing drops falling in the secondary drip chamber. Delivery from the primary container will occur when the secondary container empties.

Note:
Open Primary
Slide Clamp

If the primary administration set has a slide clamp above the pump, when the secondary infusion has completed, open the slide clamp above the pump to restart the primary infusion.

After the secondary volume remaining reaches zero, the program automatically reverts to the primary rate or to a **KVO (Keep Vein Open)** rate if no primary infusion has been programmed.

Enabling the Secondary Callback Alert Option



Figure 4-78 Select Callback Yes or No

This optional feature notifies the clinician that the secondary infusion has been completed. When configured, an alert message can be displayed with an audible alert tone when the secondary infusion completes. On the secondary programming screen, the clinician uses the \downarrow key to highlight the Callback field, then selects **Yes** or **No** for using the callback option by pressing the **Yes/No** soft key (Figure 4-78). To cancel this alert, press the **Alarm Silence** key or any of the programming keys.

If Callback is not displayed on the secondary programming screen, this feature has not been enabled.

Standby Mode

The Standby mode allows the user to preprogram a pump channel for future use without starting the infusion, or to leave the pump powered on without having a **Channel Stopped** alert occur. Standby is available for primary and secondary infusion programs. The **Open** key is disabled when the pump is on Standby; therefore, an administration set cannot be loaded or unloaded while the pump is on Standby.

Infusion data programmed in a pump on Standby is retained as long as the device is powered on.

Note: Standby mode can be used with a primary infusion, a secondary infusion, or when both a primary and secondary infusion are programmed.

Standby Activation (Single Channel Pumps)

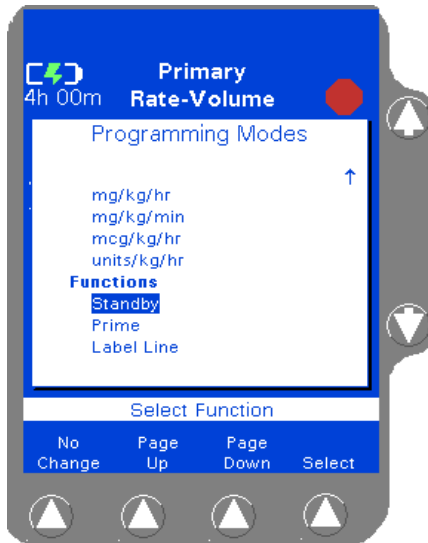

Figure 4-79 Programming Modes Menu

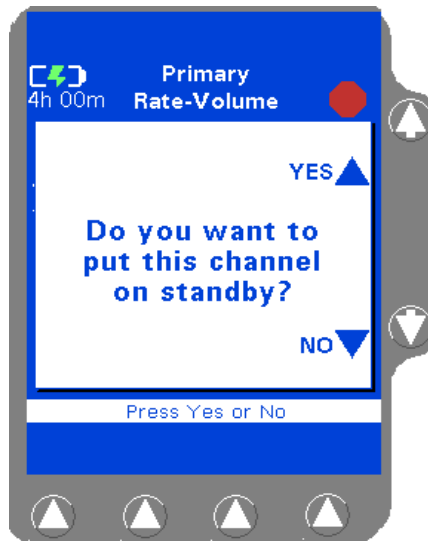

Figure 4-80 Standby Pop-up

1. Ensure the pump is stopped.
2. (Optional) To preprogram the pump for future use, program the infusion (but do not press the **START** key).
3. From the Programming screen, press the **Change Mode** soft key. The Programming Modes menu is displayed (Figure 4-79).
4. Use the $\uparrow\downarrow$ keys to highlight **Standby**, then press the **Select** soft key. The Standby pop-up is displayed (Figure 4-80).
5. Press the \uparrow key next to the **YES** shown on the pop-up to place the pump into Standby mode.



Figure 4-81 Standby Main Display

The screen changes to the Main Display and shows **Standby** where the program status information is normally displayed (Figure 4-81). If a label was selected while programming the standby infusion, the label is also shown.

Standby Activation (Triple Channel Pumps)

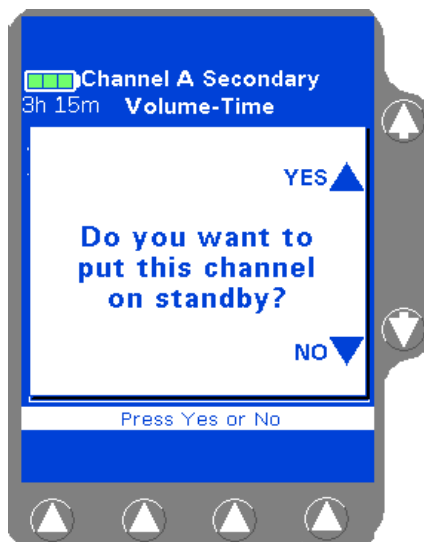

Figure 4-82 Standby Pop-up

Note: Channels B and C are on Standby when the device is first powered on.

1. Ensure the pump channel is stopped. Press the **Channel Select** key for the channel to be put on Standby.
2. (Optional) To preprogram the channel for future use, program the infusion (but do not press the **START** key).
3. Press the **Channel Select** key again. The Standby pop-up is displayed (Figure 4-82).
4. Press the $\hat{\uparrow}$ key next to the **YES** shown on the pop-up to place the channel into Standby mode.

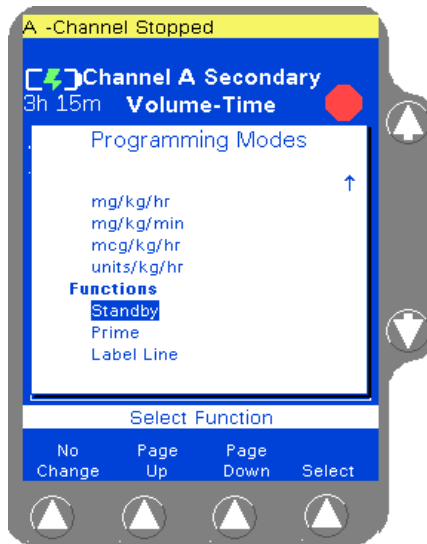

Figure 4-83 Programming Modes Menu

Note:
Alternate Standby Method

Standby can also be selected from the Programming Modes menu (Figure 4-83). After **Channel Select** is pressed (step 1 above), press the **Change Mode** soft key, then use the $\uparrow\downarrow$ keys to highlight **Standby** and press the **Select** soft key. The Standby pop-up is displayed (Figure 4-82). Continue with step 4 above.

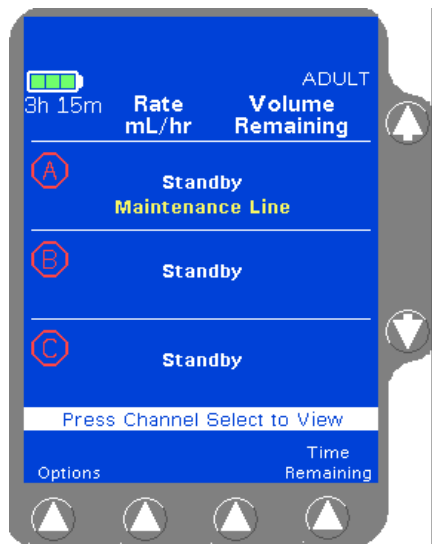

Figure 4-84 Standby Main Display

The screen changes to the Main Display and shows **Standby** where the program status information is normally displayed (Figure 4-84). If a label was selected while programming the standby infusion, the label is also shown.

Standby Deactivation

- To exit Standby mode:

<p>For single channel pumps:</p> <p>press the Primary soft key, the Rate key, or the Vol key.</p>	<p>For triple channel pumps:</p> <p>press the desired Channel Select key.</p>
-------------------------------------------------------------------------------------------------------------------------------	---------------------------------------------------------------------------------------------

The pump channel exits Standby and reverts to the programming mode in effect when it was placed on Standby.

Note: After exiting Standby, all confirmed programming will require an additional confirmation prior to starting an infusion. See “Starting a Primary Infusion After Exiting Standby,” 4-60 or “Starting a Secondary Infusion After Exiting Standby,” 4-61 as applicable.

Reconfirm Programming

Starting a Primary Infusion After Exiting Standby

To start a primary infusion if the pump channel exits Standby in primary infusion mode:

- Press the **Confirm Primary** soft key.

Note: If the **START** key is pressed before pressing the **Confirm Primary** soft key, an **Unconfirmed Primary Program** alarm occurs and a message is displayed on the prompt line.

- Press the **START** key to start the infusion.

If a secondary infusion was programmed before the pump channel was put on Standby, or if any values remain from a stopped secondary infusion, a pop-up appears (Figure 4-26 on page 4-23) warning that a primary infusion is about to start when a secondary infusion has been programmed. Press the **Done** soft key to clear the warning and do one of the following:

- Press the **START** key again to start the primary infusion, or

- Press the **Secondary** soft key to access the secondary infusion programming screen. Clear or confirm the secondary infusion program as needed. For more information about secondary infusions, see “Secondary Infusions,” 4-48.

Note: Clearing the values in the secondary program prevents the warning pop-up from reappearing when unintended. Secondary Infusion Warnings

To start a primary infusion if the pump channel exits Standby in secondary infusion mode:

1. Clear or confirm the secondary infusion program as needed.
2. Press the **Primary** soft key.
3. Press the **Confirm Primary** soft key.
4. Press the **START** key to start the infusion

If the secondary infusion was confirmed in step 1 above, a pop-up appears (Figure 4-26 on page 4-23) warning that a primary infusion is about to start when a secondary infusion has been programmed. Press the **Done** soft key to clear the warning and do one of the following:

- Press the **START** key again to start the primary infusion, or
- Press the **Secondary** soft key to access the secondary infusion programming screen. Clear or confirm the secondary infusion program as needed. For more information about secondary infusions, see “Secondary Infusions,” 4-48.

Note: Clearing the values in the secondary program prevents the warning pop-up from reappearing when unintended. Secondary Infusion Warnings

Starting a Secondary Infusion After Exiting Standby

To start a secondary infusion if the pump channel exits Standby in secondary infusion mode:

1. Press the **Confirm Secondary** soft key.
2. Press the **Primary** soft key to access the primary infusion programming screen.
3. Press the **Confirm Primary** soft key.

4. Press the **Secondary** soft key to return the secondary infusion programming screen.
5. Press the **START** key to start the infusion.

To start a secondary infusion if the pump channel exits Standby in primary infusion mode:

1. Press the **Confirm Primary** soft key.
2. Press the **Secondary** soft key to access the secondary infusion programming screen.
3. Press the **Confirm Secondary** soft key.
4. Press the **START** key to start the infusion.

Programming a Delay Start Infusion

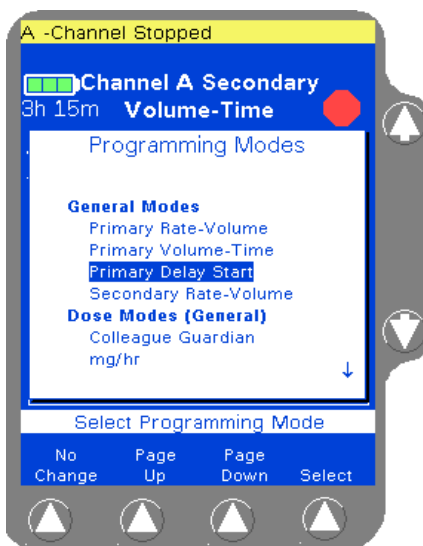

Figure 4-85 Programming Modes Menu

1. From the Main Display, access the Programming screen:

For single channel pumps:	For triple channel pumps:
press the Primary soft key or the Rate or Volume keys.	press the desired Channel Select key.

2. From the Programming screen, press the **Change Mode** soft key. The Programming Modes menu is displayed.
3. Use the $\uparrow\downarrow$ keys to highlight **Primary Delay Start** from the Programming Modes menu (Figure 4-85), then press the **Select** soft key.

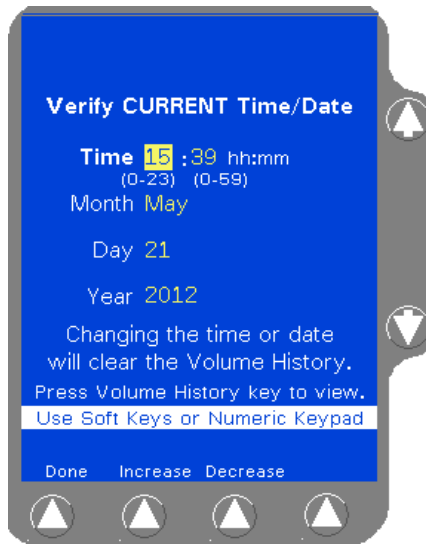

Figure 4-86 Verify CURRENT Time/Date Screen

The **Verify CURRENT Time/Date** screen is displayed, showing the current time, month, day, and year (Figure 4-86). This confirmation screen only displays the first time that Delay Start is accessed after the pump is powered on.

Note: The first Delay Start programming screen displays the CURRENT time and date, not the time and date for the infusion. The infusion start time is programmed in step 9.

4. If the current time and date are correct, press the **Done** soft key. To change the time and/or date:
 - 4.1 Use the $\uparrow\downarrow$ keys to highlight the appropriate field.
 - 4.1 Use the **Increase** or **Decrease** soft keys (or the pump's numeric keypad) to enter the CURRENT time and date.
 - 4.2 Press the **Done** soft key when the time or date is changed.

Note: Changing the current time or date clears the pump's volume history information.

To view volume history before changing time and/or date, press the **Volume History** key. Press the **Done** soft key to return to the **Verify CURRENT Time/Date** screen.



Figure 4-87 Delay Start Programming Screen

The channel's **Primary Set Delay Start** programming screen (Figure 4-87) is displayed.

5. Using the numeric keypad, enter the desired infusion rate for the delayed infusion in the **Rate** field.
6. Press the **Vol** key or the \downarrow key to highlight the **Volume to be infused** field.
7. Use the numeric keypad to enter the desired volume to be infused for the delayed infusion.
8. Press the \downarrow key to highlight the **Start At** field.



Figure 4-88 Delay Start Infusion Programming

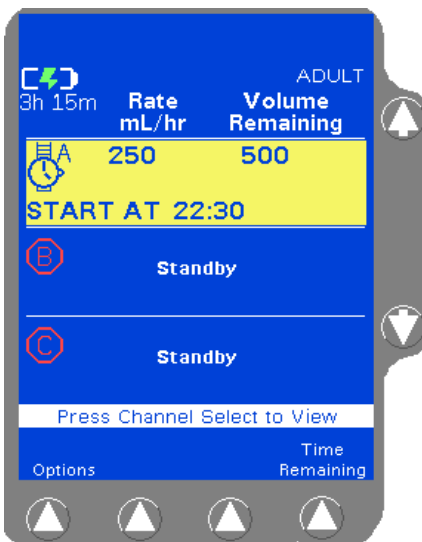

Figure 4-89 Programmed Delay Start Infusion

9. Enter the desired starting time for the delayed infusion in 24-hour hh:mm format. A time of up to 23 hours from the current time may be entered. A time of 00:00 corresponds to 12:00 midnight and a time of 23:59 corresponds to 11:59 P.M.

Example: For the infusion to start at 4:30 P.M., use the numeric keypad to enter **16:30** in the **Start At** field. (Figure 4-88).

- Valid entries for hours are 0-23
- Valid entries for minutes are 0-59

Note: To add an optional label, see “Selecting a Label” on page 4-24 for details.

10. When all fields contain valid values, the prompt line displays **Press Start to Confirm Delay Start**. Ensure the roller clamp is open and press the **START** key to initiate the Delay Start infusion so it will begin at the programmed start time. The screen displays the wristwatch icon and the programmed start time for the Delay Start infusion (Figure 4-89).

Note: The Delay Start infusion will not start at the programmed time unless the **START** key is pressed to initiate the infusion after programming.

Note: Although a Delay Start infusion can be programmed without an administration set loaded, a **Tube Not Loaded** alarm will occur when the pump channel tries to start the infusion.

Viewing Delay Start Settings Prior to the Start of Infusion

To view preprogrammed Delay Start settings prior to the start of the infusion:

1. From the Main Display:

<p>For single channel pumps: press the Primary soft key or the Rate key.</p>	<p>For triple channel pumps: press the desired Channel Select key.</p>
-------------------------------------------------------------------------------------------------------	------------------------------------------------------------------------------------------

The programmed infusion parameters are displayed on the main display and DELAY appears on the pump module display.

Note: Changing Infusion Information If the Rate or Volume to be Infused is changed, the Start At information is cleared. To place the pump back into Delay Start mode, enter a time in the **Start At** field and press the **START** key.

2. To return to the Main Display:

<p>For single channel pumps: press the Main Display key.</p>	<p>For triple channel pumps: press the desired Channel Select key.</p>
--------------------------------------------------------------------------------	------------------------------------------------------------------------------------------

If no action is taken, the screen returns to the Main Display screen after two minutes.

Exiting Delay Start Mode

To exit Delay Start mode:

1. From the Main Display, access the Programming screen:

<p>For single channel pumps: press the Primary soft key or the Rate or Volume keys.</p>	<p>For triple channel pumps: press the desired Channel Select key.</p>
-------------------------------------------------------------------------------------------------------------------------	------------------------------------------------------------------------------------------

The channel's **Primary Set Delay Start** programming screen is displayed.

2. Press the pump channel's **STOP** key. The Start At time hours are cleared. Delay Start is still the active infusion mode, but the infusion has not been completely programmed.

Note: Delay Start and Standby A completely programmed Delay Start infusion may not be placed into Standby. If the pump channel is placed into Standby with a completely programmed Delay Start infusion, the Start At time is cleared.

Note: Manual Tube Release If a Manual Tube Release alarm occurs on a pump channel with a completely programmed Delay Start infusion, the Delay Start infusion is cancelled and the Start At time is cleared.

Powering On with Delay Start Infusions

If the pump was powered off while in Delay Start Infusion mode, and the pump is powered on within the 5-hour memory retention period, the pending Delay Start infusion is cancelled and the Start At time is cleared. Delay Start is still the active infusion mode for the channel, but the infusion has not been completely programmed.

The Delay Start mode will be cancelled by using the **Change Personality** pop-up and pressing the **Select** soft key or by pressing the **New Patient** soft key.

While the Infusion is Running

Managing Volume History

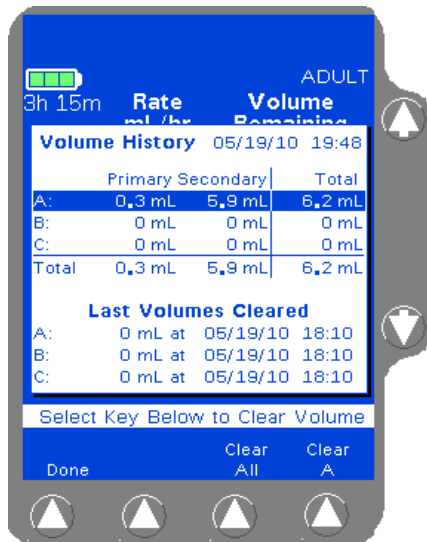

Figure 4-90 Volume History Screen

This feature provides individual and combined volume history information for each pump channel. The volume(s) infused is retained until cleared, even if the pump is powered off. The current time and date are displayed at the top of the screen. Volume History can be accessed from any screen, except configuration or service-related screens.

For each channel, the last date and time the history was cleared and the total volume cleared are also displayed in the **Last Volumes Cleared** field.

1. Press the **Volume History** key to display the Volume History screen (Figure 4-90).
2. From the Volume History screen:

For single channel pumps:	For triple channel pumps:
press the Clear Volume soft key to clear volume history for the entire device, if desired, then press the Done soft key to return to the previous screen.	press the Clear All soft key to clear volume history for the entire device, if desired, or use the $\uparrow\downarrow$ keys to highlight information for the pump channel to be cleared. Then press the Clear X soft key (where X = the channel being cleared), and then press the Done soft key to return to the previous screen.

The Volume History screen reverts to the previously displayed screen if no keys are pressed for 30 seconds.

Note: Clearing Volume History
Volume history data can be cleared for a single channel (or for all channels on triple channel pumps) while an infusion is running.

Volume history data cannot be retrieved after it has been cleared. However, the last date, time and total volume cleared will still be displayed in the **Last Volumes Cleared** field.

Changing the Primary Flow Rate During an Infusion

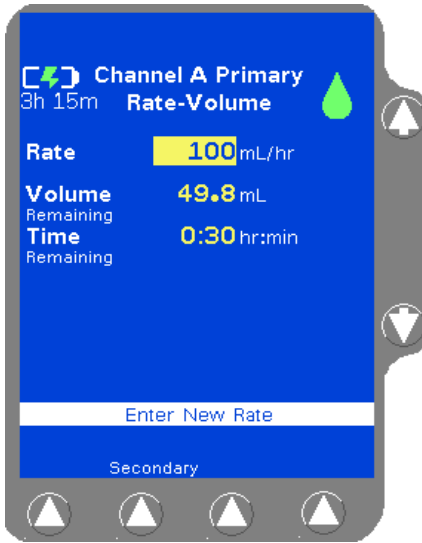

Figure 4-91 Enter New Rate

1. While the primary infusion is running:

For single channel pumps:

press the **Primary** soft key or the **Rate** key.

For triple channel pumps:

press the desired **Channel Select** key.

The **Rate** field is highlighted (Figure 4-91).

Note: Secondary Infusions

If a secondary infusion is running (secondary icon is displayed), the secondary **Rate** field is highlighted. To change the primary rate, stop the secondary infusion then press the **Primary** soft key. Primary infusion programs cannot be altered while a secondary infusion is running.

Note: Changing Primary Program Alert

While the new rate is being entered, a **Changing Primary Program** alert is active. The alert will be cleared when the infusion is started with the new rate.

2. Enter a new value using the keypad. The pump clears the **Time Remaining** value.
3. Press the **Confirm Primary** soft key.
4. Press the **START** key to begin infusing at the new rate (Figure 4-92). If the **START** key is not pressed, the pump continues infusing at the previous rate.

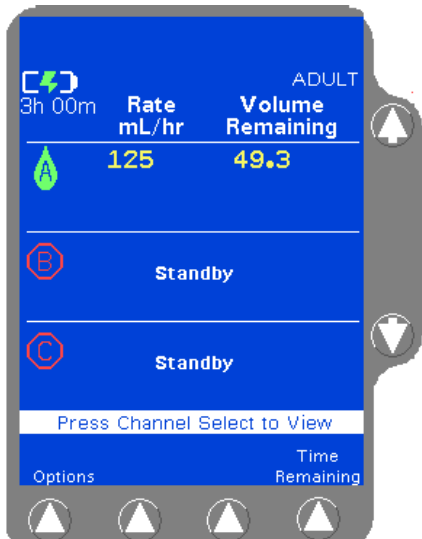

Figure 4-92 New Rate Running

Changing the Dose During an Infusion

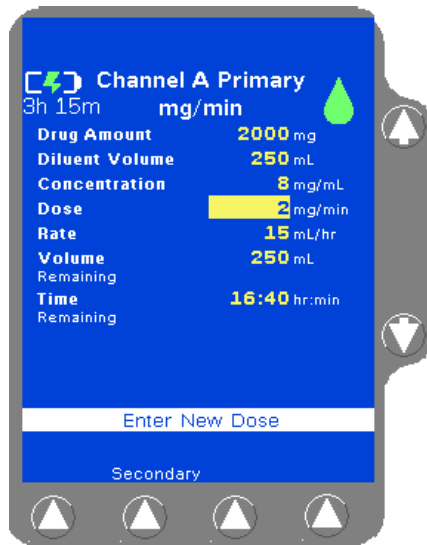

Figure 4-93 Primary Programming Screen — Infusion Running

1. While the infusion is running:

<p>For single channel pumps:</p> <p>press the Primary soft key.</p>	<p>For triple channel pumps:</p> <p>press the desired Channel Select key.</p>
-----------------------------------------------------------------------------------	---------------------------------------------------------------------------------------------

The **Dose** field is highlighted automatically (Figure 4-93).

Note: While the new dose is being entered, a **Changing Primary Program Alert** is active. The alert will be cleared when the infusion is started with the new rate.

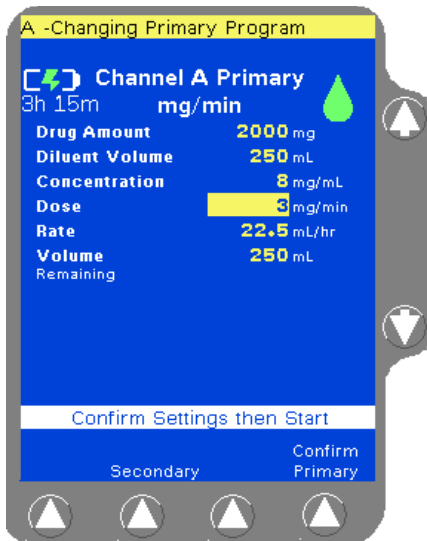

Figure 4-94 Enter New Dose

2. Enter the new dose using the numeric keypad. The pump automatically calculates the new infusion rate (Figure 4-94).
3. Check the programmed values, then press the **Confirm Primary** soft key.
4. Press the **START** key to begin the infusion using the new dose. If the **START** key is not pressed, the pump continues infusing at the previous dose.

Changing Volume, Weight or Concentration During an Infusion

Use this procedure to change volume to be infused, patient weight, or concentration of the infusion currently shown on the display.

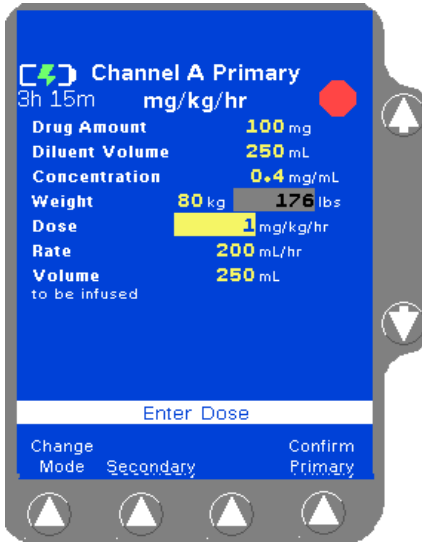

Figure 4-95 Dose Field Highlighted

1. Stop the infusion. Drug amount, diluent volume, concentration, and patient weight cannot be changed while the infusion is running:

For single channel pumps:

press the **STOP** key.

For triple channel pumps:

press the **STOP** key for the desired channel.

The **Dose** field is highlighted (Figure 4-95).

Note:
Secondary
Infusions

If a secondary infusion is running (secondary icon is displayed), the secondary **Rate** field is highlighted. To change primary infusion parameters, stop the secondary infusion, then press the **Primary** soft key. Primary infusion programs cannot be altered while a secondary infusion is running.

2. Use the $\uparrow\downarrow$ keys to highlight the field to be change.

Note:
Changing
Concentration

If the Concentration field is changed, the pump forces the Drug Amount and Diluent Volume to be entered. If the Drug Amount or Diluent Volume fields are changed, the pump recalculates the concentration.

3. Enter the new value(s) using the numeric keypad. The pump automatically recalculates the other parameters (Figure 4-96).

Note:
Parameters
Outside Limits

If the entries result in a value outside the range of the current PERSONALITY feature set, or outside the pump's capabilities, **High** or **Low** is displayed in the field. Reprogram other parameters so that the value is within the limits.

If a **Volume to be Infused** is entered that is greater than the Diluent Volume, **High** is displayed in the **Volume to be Infused** field. The Volume to be Infused cannot exceed the diluent volume.



Figure 4-96 New Values Entered, Other Parameters Recalculated

4. Check the programmed values, then press the **Confirm Primary** soft key.
5. Press the **START** key to resume the infusion using the new values.

Adding or Changing a Label Line During an Infusion

If the Label Library feature is enabled, use the procedure below to select an informational label during an infusion.

1. From the Main Display:

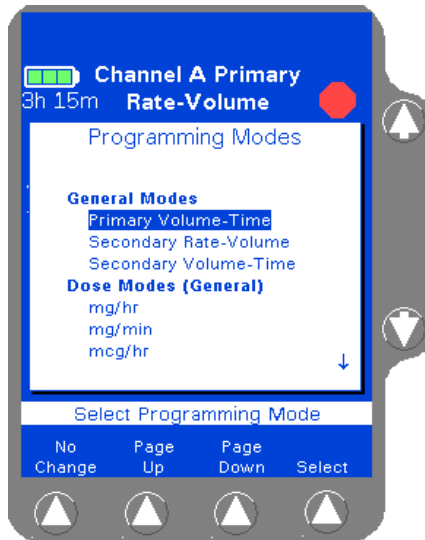

Figure 4-97 Programming Modes Menu

For single channel pumps:	For triple channel pumps:
press the STOP key, then press the Primary soft key.	press the STOP key on the desired pump channel, then press the Channel Select key.

2. Press the **Change Mode** soft key. The Programming Modes menu is displayed (Figure 4-97).
3. Highlight **Label Line** (under **Functions**) using the $\uparrow\downarrow$ keys, then press the **Select** soft key.

A list of labels and their abbreviations is displayed as shown in Figure 4-29. If the list consists of more than one screen, use the **Page Up** and **Page Down** soft keys to view the next screen of labels.

Note: Labels configured using the COLLEAGUE GUARDIAN feature do not appear in the label list.

4. Highlight the label to be selected using the $\uparrow\downarrow$ keys, then press the **Select** soft key. When the **Select** soft key is pressed, the Programming screen is displayed, showing the selected label.
5. Press the **START** key to resume the infusion.

Viewing COLLEAGUE GUARDIAN Limits During an Infusion

Use this procedure to view the COLLEAGUE GUARDIAN programming limits for the infusion currently shown on the display.

1. While the infusion is running:

For single channel pumps:

press the **Primary** soft key or the **Rate** or **Volume** keys.

For triple channel pumps:

press the desired **Channel Select** key.

2. Press the **View Limits** soft key (Figure 4-98).

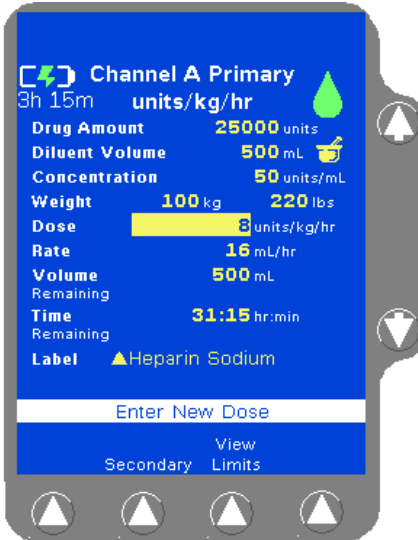

Figure 4-98 View Limits Soft Key



Figure 4-99 Limits Display Pop-up

3. The limits for the label are displayed in a pop-up window (Figure 4-99). Press the **Done** soft key to close the pop-up.
4. Press the **Main Display** key or the **START** key to exit the programming screen.

Note:
Changing COLLEAGUE GUARDIAN Labels

To change to a different COLLEAGUE GUARDIAN drug label, the infusion must first be stopped. Press the **STOP** key on the desired pump channel, then press the **Channel Select** key and the **Change Mode** soft key. Select **Colleague Guardian** from the Programming Modes menu; select a new COLLEAGUE GUARDIAN drug label from the list and program a new infusion.

Changing the Secondary Flow Rate During an Infusion

Use this procedure to change the flow rate of the infusion currently shown on the display.

1. While the secondary infusion is running:

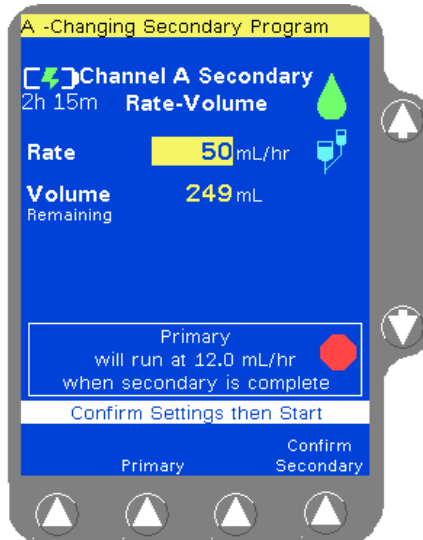

Figure 4-100 Enter New Secondary Rate

<p>For single channel pumps:</p> <p>press the Secondary soft key or the Rate key.</p>	<p>For triple channel pumps:</p> <p>press the desired Channel Select key.</p>
------------------------------------------------------------------------------------------------------------	---------------------------------------------------------------------------------------------

The **Rate** field is highlighted (Figure 4-100).

2. Enter a new value using the keypad. The pump clears the **Time Remaining** value.
3. Press the **Confirm Secondary** soft key.
4. Press the **START** key to begin infusing at the new rate. If the **START** key is not pressed, the pump continues infusing at the previous rate.

Panel Lockout

Activating/Deactivating Panel Lockout

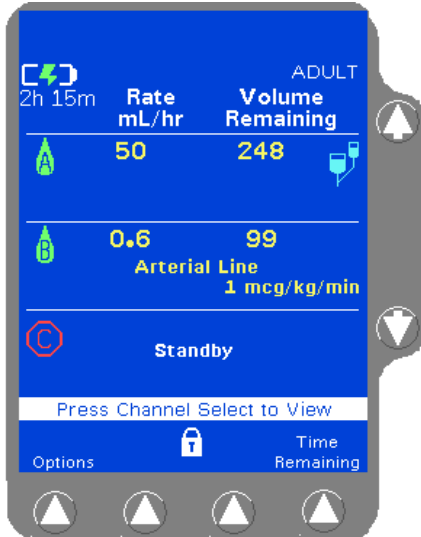

Figure 4-101 Panel Locked with Primary Running, No Alarm or Alert

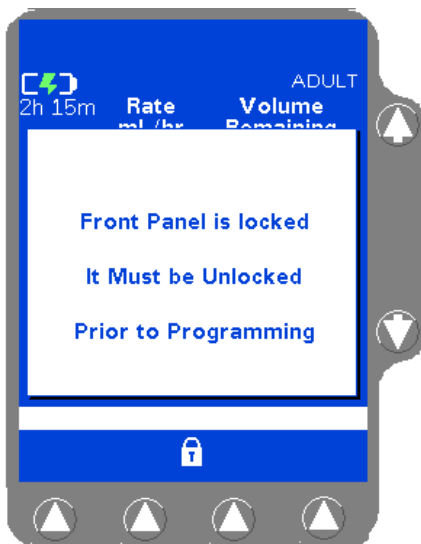

Figure 4-102 Front Panel Locked Invalid Key Pressed

The Panel Lockout feature helps minimize the potential for keypad tampering. It disables all the front panel keys except the **Main Display**, **Volume History**, **Channel Select** (for triple channel pumps only), and **Back Light** keys, and the **Options**, **Primary**, and **Secondary** soft keys for viewing.

Panel Lockout can only be enabled from the Main Display or the Programming screen when the following conditions are met:

- no alarms or alerts are present
- for single channel pumps: an infusion is running
- for triple channel pumps: all infusions are running, or up to two infusions are on Standby. Panel Lockout cannot be enabled if all three pump modules are on Standby.

To enable the panel lockout function, press the PANEL LOCKOUT button located on the back of the pump. The Lock icon is displayed between the second and third soft keys on the main display (Figure 4-101).

If disabled keys are pressed when the keypad is locked, the Panel Locked pop-up is displayed (Figure 4-102).

To unlock the front panel, press the PANEL LOCKOUT button again.

Auto Lock

Auto Lock is available as a configurable option. This option automatically locks the front panel keys when the following conditions are true:

- for single channel pumps: an infusion is running
- for triple channel pumps: all infusions are running, or up to two infusions are on Standby
- no alarms or alerts are present
- no key presses have occurred in the last 2 minutes.

Completing an Infusion

Stopping a Primary Infusion Before Completion

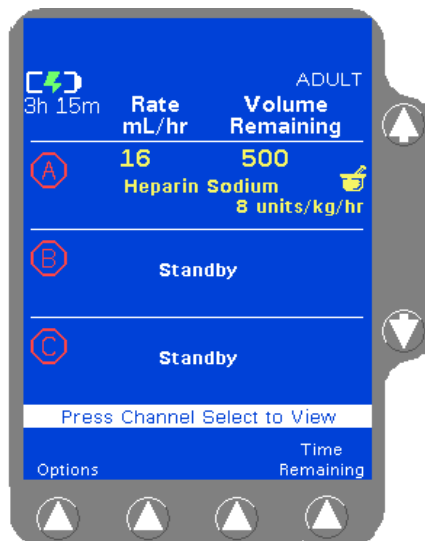

Figure 4-103 *Infusion Stopped*

1. To stop an infusion before completion, press the **STOP** key on the appropriate pump module.

A stop icon displays on the Main Display (Figure 4-103) and the RUNNING LED is no longer illuminated for that channel. The pump module displays STOPPED.

If the pump is not restarted within two minutes, or no keys are pressed for 30 seconds, a **Channel Stopped** alert will sound.

Note: Do not cut the tubing to remove the administration set from the channel. If the tubing is cut, remove the slide clamp immediately.

Note: If other channels are being used, this pump channel should be placed in Standby mode so that a **Channel Stopped** alert will not be activated. (Triple Channel Pumps Only)

For triple channel pumps only: To place one pump channel in Standby mode, stop the channel, then press the corresponding **Channel Select** key twice (once to select, once to deselect), or see “Standby Activation (Triple Channel Pumps),” 4-58.

To restart the infusion:

For single channel pumps:

press the **Primary** soft key, then press the **START** key.

For triple channel pumps:

press the **Channel Select** key on the desired pump channel, then press the **START** key.

Stopping a Secondary Infusion Before Completion

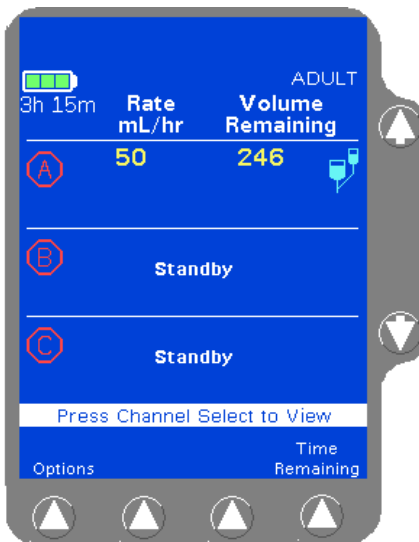

Figure 4-104 Secondary Stopped

1. Press the **STOP** key on the desired pump module.

A stop icon displays on the Main Display (Figure 4-104) and the RUNNING LED is no longer illuminated for that channel. The pump module displays STOPPED.

2. Close the On/Off clamp on the secondary administration set. If the primary set has a regulating clamp above the pump, open the regulating clamp.
3. To start the primary infusion:

For single channel pumps:

press the **Primary** soft key, then press the **START** key.

For triple channel pumps:

press the **Channel Select** key on the desired pump channel, then press the **Primary** soft key, then press the **START** key.

To restart the secondary infusion, close the regulating clamp on the primary set (if applicable), open the On/Off clamp on the secondary administration set, and:

For single channel pumps:

press the **Secondary** soft key, then press the **START** key.

For triple channel pumps:

press the **Channel Select** key on the desired pump channel, then press the **START** key.

Note: Do not cut the tubing to remove the administration set from the channel. If the tubing is cut, remove the slide clamp immediately.

Infusion Complete (Switch to KVO)

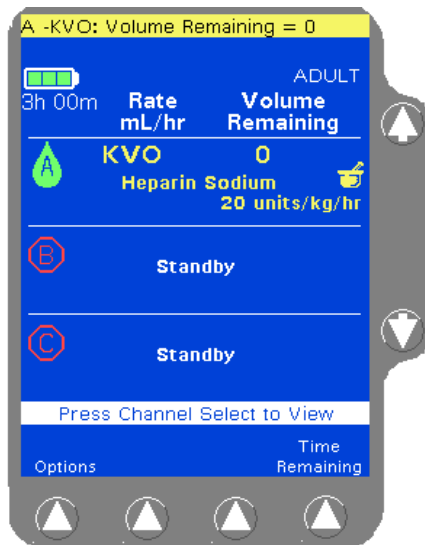

Figure 4-105 KVO Display

When the volume remaining reaches zero, the pump automatically enters a KVO (Keep Vein Open) alert mode (Figure 4-105).

During this alert mode, the pump continues infusing at a preconfigured KVO rate or at the programmed rate, whichever is less. See “Configurable Options,” 6-1.

To exit the alert, press the **STOP** key on the appropriate pump channel and:

- program the pump for the next infusion if appropriate,
- place the channel in standby, or
- power off the pump.

Note: For triple channel pumps: If other channels are being used, this pump channel should be placed in Standby mode so that a **Channel Stopped** alert will not be activated.

Note: Do not cut the tubing to remove the administration set from the channel. If the tubing is cut, remove the slide clamp immediately.

Unloading the Administration Set

Automatic Unloading



Note: The pump must be powered on to unload the administration set. See “Powering On Using AC Power,” 4-1.

1. If the pump module is running, press the **STOP** key on the pump module to stop it.
2. **Close the regulating clamp on the administration set.**
3. Press the **Open** key on the pump module. The mechanism closes the keyed slide clamp and opens the tubing channel. When an arrow is displayed on the pump module, the tubing channel is open.

! WARNING !

While the pump automatically closes the keyed slide clamp, always close the regulating clamp on the administration set before loading or removing the administration set from the pump.

CAUTION

When attempting to load or unload an administration set, do not insert tools or other objects into the tubing channel.

4. When the arrow is displayed on the pump module display, grasp the administration set on both sides of the pump and remove it from the tubing channel. The mechanism closes automatically 60 seconds after the administration set has been removed.

The administration sets should be disposed of in an appropriate manner, considering the nature of the residual fluid that may be contained within, in accordance with the facility disposal practices.

Note: Loading Mechanism Disabled If the loading mechanism is disabled (for example, the battery has depleted), see “Using the Manual Tube Release,” 4-79, for instructions on unloading the administration set manually.

Note: Do not cut the tubing to remove the administration set from the channel. If the tubing is cut, remove the slide clamp immediately.

Using the Manual Tube Release

Use Manual Tube Release only when the Tube Loading Mechanism is NOT functioning, or if a channel failure occurs.

Note: The pump will not turn on if the Manual Tube Release is in the open position.

For triple channel pumps: If the Manual Tube Release is used, the remaining pump channels cannot be programmed until the Manual Tube Release is reset.

Never use the Manual Tube Release to load or unload the administration set during normal operation.

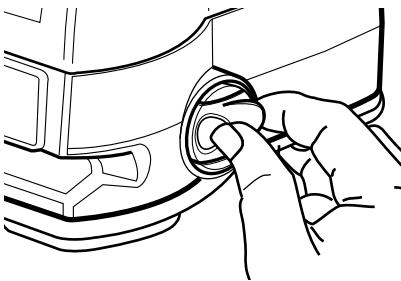

A

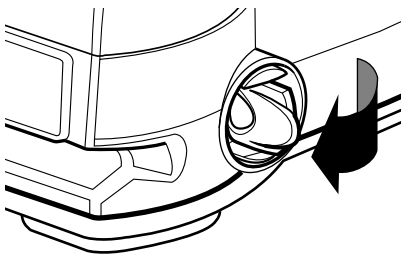

B

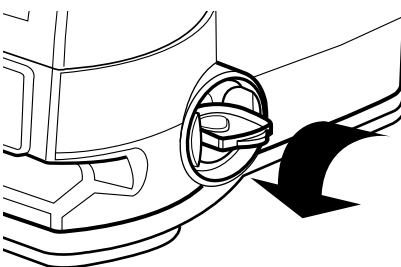

C

Figure 4-106 Using the Manual Tube Release

1. **Close the regulating clamp on the administration set.**
2. Locate the appropriate Manual Tube Release mechanism on the right side of the pump, when facing the front panel.
3. Push and grasp the release tab (see Figure 4-106A), turning it out (see Figure 4-106B).
4. Rotate the tab counterclockwise until it stops (see Figure 4-106C). This closes the keyed slide clamp and opens the pump mechanism.

Note: MTR Activation with Pump Off If the pump is off when the Manual Tube Release is activated, it will automatically turn itself on. The **Reset Manual Tube Release** alarm occurs and the Reset Manual Tube Release screen is displayed (Figure 4-107).

5. Remove the administration set from the pump.

The Reset Manual Tube Release screen may not display if a pump failure has occurred.

If the pump is on with no administration set in the tubing channel, a **Reset Manual Tube Release** alarm occurs and the Reset Manual Tube Release screen is displayed (Figure 4-107).

If the pump is on and the administration set is in the tubing channel when the Manual Tube Release is activated, a **Close Regulating Clamp** alarm occurs. **Close the regulating clamp on the administration set**, remove the administration set, and then reset the mechanism.

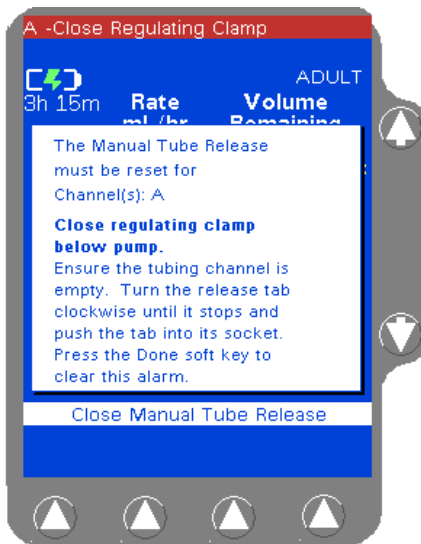

Figure 4-107 Reset Manual Tube Release Pop-up

Resetting the Manual Tube Release

If a channel failure occurs and an attempt is made to power off the pump without first resetting the Manual Tube Release, the Reset Manual Tube Release pop-up is displayed (Figure 4-107).

Reset the Manual Tube Release as follows:

1. **Close the regulating clamp on the administration set.** Ensure there is no administration set or foreign object in the tubing channel.
2. Turn the release tab (Figure 4-106A) clockwise until it stops and push the tab into its socket.
3. For triple channel pumps: Repeat the steps above as needed for additional channels.
4. The **Done** soft key is displayed when the Manual Tube Release is reset for all affected channels. Press the **Done** soft key to clear the alarm.

Note: MTR After Channel Failure
If the Manual Tube Release is used following a channel failure to remove the administration set, the pump cannot be powered off until the Manual Tube Release has been reset. A Reset Manual Tube Release pop-up message will be displayed.

Note: Number of MTR Attempts
If three unsuccessful attempts to reset the Manual Tube Release are made, a channel failure occurs. The pump cannot be used until the Manual Tube Release is reset and the pump is powered off and back on.

Powering Off the Pump

! WARNING!

While the pump automatically closes the keyed slide clamp, always close the regulating clamp on the administration set before loading or removing the administration set from the pump.

1. Press the **ON/OFF CHARGE** key to power off the pump. A Power Off pop-up displays (Figure 4-108).

If the pump is operating on battery power, low battery, or depleted battery, the pop-up window alerts the user to that condition (Figure 4-109).

To resume operation, press the **Return** soft key.

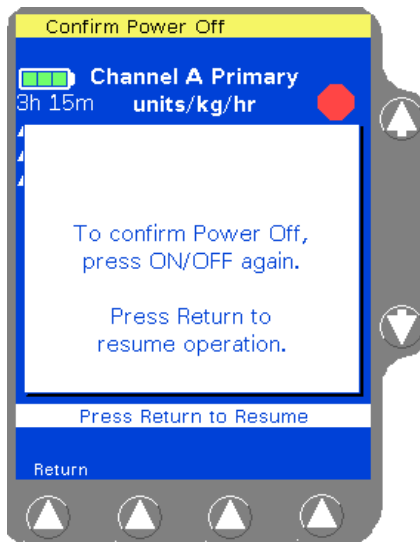

Figure 4-108 Standard Power Off Pop-up



Power Off Pop-up on Battery Power



Power Off Pop-up on Low Battery



Power Off Pop-up on Depleted Battery

Figure 4-109 Battery Power Off Pop-ups

2. Press the **ON/OFF CHARGE** key again to power off the pump.

To power off an individual channel on a triple channel pump, see “Standby Activation (Triple Channel Pumps),” 4-58.

Note:
Panel Lockout The **ON/OFF CHARGE** key is disabled if the front panel is locked. Press the PANEL LOCK button on the back of the pump to unlock the panel, then power off the pump.

Note:
MTR If a Manual Tube Release has been used due to a channel failure, the Manual Tube Release pop-up will be displayed prior to power-off. Any open Manual Tube Release(s) must be fully reset before the device can be powered off. See “Resetting the Manual Tube Release,” 4-80, for instructions.

Note:
Tube Misloaded
Alarm The pump cannot be powered off if a **Tube Misloaded** alarm is active. This alarm occurs if the **ON/OFF CHARGE** key is pressed before the pump finishes loading or unloading the tubing.

Options Menu

Overview

The Options Menu allows selection of the following functions:

- Flow check display
- View current PERSONALITY feature set
- Clinician modification of downstream occlusion level
- Configuration/service functions (password required)

To access the Options Menu:

1. From the Main Display, press the **Options** soft key to access the Options Menu as shown in Figure 4-110.
2. Use the $\uparrow\downarrow$ keys to highlight a function and then press the **Select** soft key to access that function.

The Battery Charge Level is displayed whenever the Options Menu is viewed; it is not a selectable option. Approximate battery time remaining is displayed in hours and minutes, and a battery charge icon shows an indication of the current battery charge level. See “Battery Charge Icon Descriptions,” 4-8 for more information about the battery charge level icons.

To exit the Options Menu and return to the Main Display screen, press the **Done** soft key or the **Main Display** key.

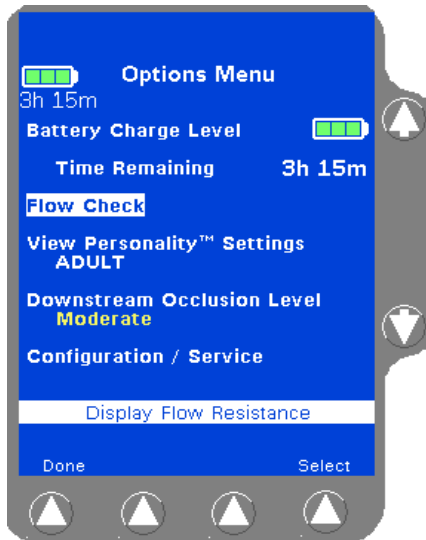

Figure 4-110 Options Menu

Managing Occlusion Settings

When enabled, the clinician can temporarily modify the downstream occlusion level of all channels using the Options Menu.

1. Press the **Options** soft key from the Main Display to access the Options Menu.
2. Use the $\uparrow\downarrow$ keys to highlight the **Downstream Occlusion Level** setting and then press the **Select** soft key (Figure 4-111).

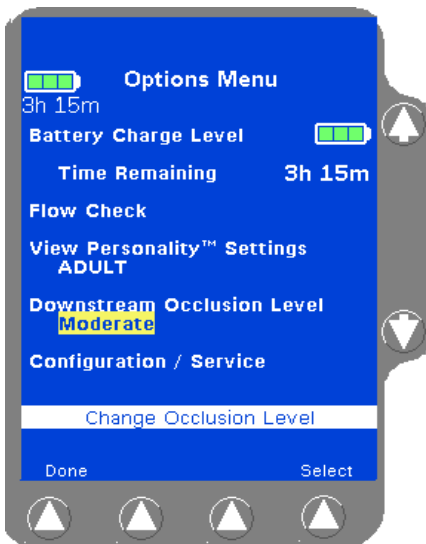

Figure 4-111 Downstream Occlusion Level Setting



Figure 4-112 Downstream Occlusion Level Pop-up

If enabled, the **Downstream Occlusion Level** pop-up is displayed (Figure 4-112). Downstream occlusion levels are displayed, and the present setting is highlighted.

3. The occlusion level can be modified by using the $\uparrow\downarrow$ keys to highlight the new setting, then press the **Select** soft key to choose the selection.
4. To exit the Options Menu, press the **Done** soft key, or the **Main Display** key to return to the Main Display Screen.

If the Options Menu is used to modify the Downstream Occlusion values, the override values are not permanently saved. When the pump is powered off, the downstream occlusion values revert to the configuration defined by the facility.

For information on the specific rate ranges/values for the downstream occlusion levels, see page 9-3 in Chapter 9 - "Technical Specifications".

Note: At the **Minimum** setting, the pump will be more sensitive to changes in downstream occlusion pressure. At this setting, the **Downstream Occlusion** alarm may occur more frequently.

At the **Maximum** setting, the pump will be less sensitive to changes in downstream occlusion pressure. At this setting, the **Downstream Occlusion** alarm may occur less frequently.

Auto Restart

When configured by facility-authorized personnel, the Auto Restart option enables the pump to automatically restart itself when a downstream occlusion has been corrected within approximately one minute after detection. Each pump channel will continue to restart for up to nine occurrences (or as configured) before manual intervention is required.

Selecting a different downstream occlusion alarm level does not affect the Auto Restart feature.

Pressing any key during a Downstream Occlusion alarm disables Auto Restart.

Viewing PERSONALITY Settings

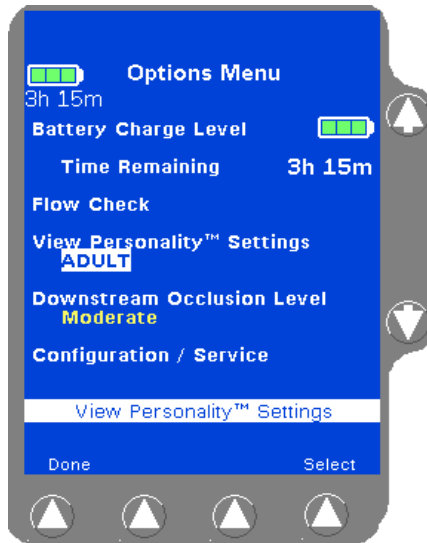

Figure 4-113 Highlight Name of Current PERSONALITY Feature Set

From the Options Menu, use the $\uparrow\downarrow$ keys to highlight the name of the current PERSONALITY feature set and press the **Select** soft key (Figure 4-113).

The resulting screens allow all the configuration settings for the current PERSONALITY feature set to be viewed.

See “Selecting a Pump PERSONALITY Feature Set,” 4-5 for additional information on selecting a PERSONALITY feature set.

If the current PERSONALITY feature set shown is **Permanent Settings**, custom configurations are not selected. See “Configurable Options,” 6-1 for factory settings.

Using Flow Check Display

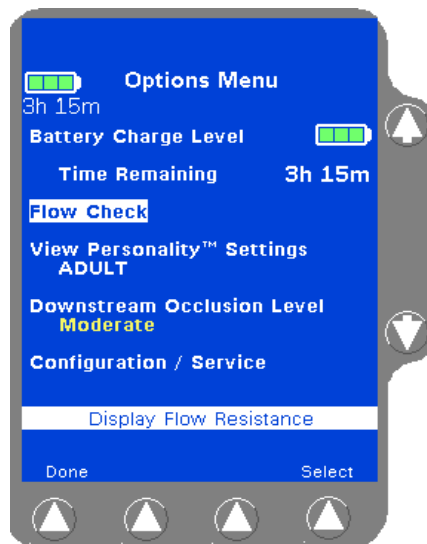

Figure 4-114 Options Menu

The Flow Check display feature provides a visual indication of downstream resistance to flow for each pump channel. The Flow Check display appears on the Main Display screen. Resistance to flow is indicated by the number of filled triangles. One filled triangle indicates normal conditions. If Flow Check is enabled in the currently selected PERSONALITY, the Flow Check display appears below the channel indicators on the Main Display screen for each running channel. If Flow Check is not enabled for the currently selected personality, follow the steps below to see the display:

1. Press the **Options** soft key from the Main Display to access the Options Menu shown in Figure 4-114.

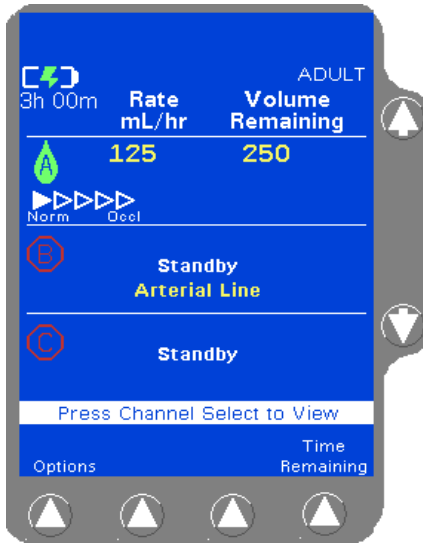

Figure 4-115 Flow Check Main

2. Use the $\uparrow\downarrow$ keys to highlight **Flow Check** and then press the **Select** soft key. The status is displayed on the Main Display for 10 seconds (Figure 4-115).
3. To exit the Options Menu, press the **Done** soft key, or the **Main Display** key to return to the Main Display screen.

Using the Configuration/Service Function

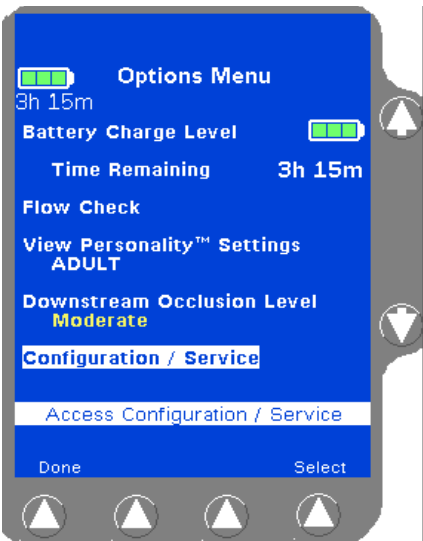

Figure 4-116 Options Menu
Select Configuration/Service

This function is for use by Baxter-trained, qualified personnel only. Accessing this function requires a passcode (Figure 4-116). See the *COLLEAGUE Pump Global Service Manual* and the *COLLEAGUE Pump Configuration Manual* for details.

Optional Pump Accessories

This chapter describes the optional accessories available for use with the pump.

This pump should be used only with Baxter accessories specified in this chapter. Using anything other than the recommended accessories with this pump will result in operation that is not within the constraints and parameters of the device.

Note: Accessories may not be available for use in all countries.

! WARNING !

The use of accessories and cables other than those specified in this manual, with the exception of cables sold by Baxter as replacement parts for internal components, may result in increased emissions, decreased immunity or may result in operation that is not within the constraints and parameters of the device.

Use only accessory equipment complying with the device's safety requirements; failure to do so may lead to reduced safety levels of the resulting system.

Consideration relating to accessory choice shall also include:

- Use of the accessory in the patient vicinity
- evidence the safety certification of the accessory has been performed in accordance with the appropriate UL 60601-1 or IEC/EN 60601-1 harmonized national standard.

Syringe Adapter

The Syringe Adapter (Baxter product code 2D0300) and syringe adapter administration set allow the pump to deliver fluid from a syringe. Follow the directions provided with the Syringe Adapter and syringe adapter administration set. This accessory is suitable for use in the patient environment.

COLLEAGUE GUARDIAN Configuration Tool

This accessory (Baxter product code 2M9541) consists of a PC-based configuration tool that can be used to configure COLLEAGUE pump PERSONALITY features, enter custom labels, and define COLLEAGUE GUARDIAN limits and transfer them to COLLEAGUE pumps with the COLLEAGUE GUARDIAN Feature.

The pump should not be connected to a patient while the COLLEAGUE GUARDIAN Configuration Tool is in use; it is not suitable for use in the patient environment.

COLLEAGUE DL2 Event History Download Application

The COLLEAGUE DL2 Event History Download Application (Baxter product code 2M9530) is a PC-based tool that allows the event history information from COLLEAGUE pumps to be downloaded, viewed, printed, and copied to an electronic file.

The pump should not be connected to a patient while the COLLEAGUE DL2 Event History Download Application is in use; it is not suitable for use in the patient environment.

Configurable Options

Overview

This chapter lists the pump's configurable features and their initial factory settings. The configurable options are grouped into the following categories:

- “General Pump Options” on page 6-2
- “COLLEAGUE GUARDIAN Feature Options” on page 6-3
- “Options Specific to PERSONALITY Feature Sets” on page 6-4
- “Label Library” on page 6-7

Note: Changes to the configurable settings can only be made by facility-authorized personnel. To change settings, an access code is required. To create a custom PERSONALITY feature set or to change initial factory settings, see the *COLLEAGUE Pump Configuration Manual* or the *COLLEAGUE Guardian Configuration Tool User's Guide*. The PERSONALITY feature set named Permanent Settings cannot be changed.

Note: Authorized healthcare professionals should establish the settings appropriate for each custom PERSONALITY feature set and COLLEAGUE GUARDIAN label based upon clinical needs.

Note: Program Memory Retention Time is set to 5 hours. This is the amount of time the pump retains infusion parameters and the PERSONALITY feature set selection when the pump is turned off.

General Pump Options

The configurable option settings listed in Table 6-1 affect the operation of the pump regardless of the selected PERSONALITY feature set or label.

Table 6-1 General Pump Options

Option	Available Setting	Factory Setting
PERSONALITY Configuration Settings	One permanent and up to eight custom PERSONALITY feature sets. Available (Enable) Unavailable (Disable)	Permanent Settings PERSONALITY feature set Enabled
Custom Label List	Up to 436 custom labels can be configured. After custom labels have been configured, they can then be configured with programming limits using the COLLEAGUE GUARDIAN feature. Custom labels can then be enabled or disabled individually for each PERSONALITY feature set.	No custom labels defined
COLLEAGUE GUARDIAN Feature	For all predefined medication labels and custom labels in the pump's label library, programming limits can be configured which will result in warnings to the clinician if they try to program parameters which exceed the predefined limits for that label configured by the care site.	No Entry for any labels
Time Setting (Real time entered in hours and minutes)	Hours: Minutes	Central Standard Time
Date Setting	Month/Day/Year	Current date for U.S. (CST) in MMDDYY format
Rate-Volume Infusion Mode	Always available and cannot be disabled. (Enabled)	Always enabled
Power On Default PERSONALITY Settings	All named PERSONALITY feature sets. Available (Enable) Unavailable (Disable)	Permanent settings (1) Enabled

COLLEAGUE GUARDIAN Feature Options

Table 6-2 lists the infusion modes and parameters that can be programmed using the COLLEAGUE GUARDIAN feature. The COLLEAGUE GUARDIAN feature allows default programming parameters to be set independently for medication/solution labels and custom labels in the pump’s label library. In order for a COLLEAGUE GUARDIAN label to be available for use in any given PERSONALITY feature set, the following must be true:

- The label must be enabled in the selected PERSONALITY feature set.
- The dose mode used by the COLLEAGUE GUARDIAN label must also be enabled in the selected PERSONALITY feature set.
- The limits programmed for the COLLEAGUE GUARDIAN label must be within the infusion limits of the selected PERSONALITY feature set.

Note: The COLLEAGUE GUARDIAN feature cannot be used with the 13 application labels.

Table 6-2 Parameters Programmable Using the COLLEAGUE GUARDIAN Feature

Infusion Mode	Programmable Parameters	Available choices
mL/hr	Rate	Low and high limits must be programmed that are within the pump’s specifications. If the value is outside the pump’s capabilities, High or Low is displayed. Optionally, a default rate can also be entered.
mg/hr mg/min mcg/hr mcg/min units/hr mEq/hr mg/kg/hr mg/kg/min mcg/kg/hr mcg/kg/min units/kg/hr mEq/kg/hr	Drug Amount	Any amount within the pump’s specifications. The values are recalculated as values are entered for the other parameters. If the resulting value is outside the pump’s capabilities, High or Low is displayed.
	Diluent Volume	Any amount within the pump’s specifications. The values are recalculated as values are entered for the drug amount and diluent volume. If the resulting value is outside the pump’s capabilities, High or Low is displayed.
	Concentration	Any amount within the pump’s specifications. The values are recalculated as values are entered for the other parameters. If the resulting value is outside the pump’s capabilities, High or Low is displayed. Low and high limits may be programmed only if Default Override is set to Enabled.
	Default Override	If enabled, allows the clinician to change the default values for drug amount, diluent volume, and concentration. Changes are indicated on the programming screen by a triangle next to the affected item. Labels for which changes to these parameters are allowed are indicated by a triangle to the left of the label in the COLLEAGUE GUARDIAN label list.
	Dose	Low and high limits must be programmed that are within the pump’s specifications. If the value is outside the pump’s capabilities, High or Low is displayed. Optionally, a default dose can also be entered.

Options Specific to PERSONALITY Feature Sets

The options listed in Table 6-3 can be set independently for each PERSONALITY feature set.

Table 6-3 Options Specific to a PERSONALITY Feature Set

Option	Available Settings	Factory Settings
Volume-Time Infusion Mode	Available (Enable) Unavailable (Disable)	Enabled
Delay Start	Available (Enable) Unavailable (Disable)	Disabled
Secondary Infusion Mode	Available (Enable) Unavailable (Disable)	Enabled
Dose Infusion Modes	Available (Enable) Unavailable (Disable)	Enabled
Individual dose formulas	mg/hr mg/min mcg/hr mcg/min units/hr mEq/hr mg/kg/hr mg/kg/min mcg/kg/hr mcg/kg/min units/kg/hr mEq/kg/hr (When Dose Infusion Modes is enabled, individual modes can be enabled or disabled.)	Enabled Enabled Enabled Enabled Enabled Disabled Enabled Enabled Enabled Enabled Enabled Disabled
Pump Channel Message Display	<ul style="list-style-type: none"> • Rate (mL/hr), used if no label is selected • Time Remaining (Before KVO) • Label (the Label Library feature and individual labels must be enabled) • Volume Infused (mL) 	Rate
Prime Feature	Available (Enable) Unavailable (Disable) (Enables priming for administration sets difficult to gravity-prime.)	Enabled

Table 6-3 Options Specific to a PERSONALITY Feature Set — continued

Option	Available Settings	Factory Settings																
Flow Check Display	Always displayed when the pump is running (Enable) Display on demand (Disable) (Provides visual indication of distal resistance to flow.)	Disabled																
Patient weight units	kg and lbs (allows patient weight to be entered using metric or English units) kg (allows patient weight to be entered in metric units only) lbs (allows patient weight to be entered in English units only)	kg and lbs																
Patient weight limits	Selectable from 0.2 kg (0.44 lb) to 600 kg (1322 lb) in kg (High limit cannot be less than low limit; low limit cannot exceed high limit)	0.2 kg 600 kg																
Infusion Rate Limits	0.1 mL/hr to 1200 mL/hr (Secondary limited to 500 mL/hr or the infusion rate limit, whichever is less.)	1200 mL/hr																
Volume To Be Infused Limit	0.1 mL to 9999 mL	9999 mL																
KVO Rate Limit	0.1 mL/hr to 5 mL/hr (Pump infuses at the preselected KVO rate or the programmed rate, whichever is lower. Cannot exceed the infusion rate limit.)	5 mL/hr																
Air Alarm Sensitivity	Measured accumulations of approximately <ul style="list-style-type: none"> • 25 Microliters • 50 Microliters • 100 Microliters • 150 Microliters 	150 Microliters																
Nominal Downstream Occlusion Level Power On	<p>Rate Range in mL/hr</p> <table border="0"> <tr> <td><21</td> <td>21-200</td> <td>>200</td> <td></td> </tr> <tr> <td>103 mmHg (2 psig)</td> <td>207 mmHg (4 psig)</td> <td>310 mmHg (6 psig)</td> <td>Minimum</td> </tr> <tr> <td>258 mmHg (5 psig)</td> <td>414 mmHg (8 psig)</td> <td>569 mmHg (11 psig)</td> <td>Moderate</td> </tr> <tr> <td>465 mmHg (9 psig)</td> <td>620 mmHg (12 psig)</td> <td>775 mmHg (15 psig)</td> <td>Maximum</td> </tr> </table>	<21	21-200	>200		103 mmHg (2 psig)	207 mmHg (4 psig)	310 mmHg (6 psig)	Minimum	258 mmHg (5 psig)	414 mmHg (8 psig)	569 mmHg (11 psig)	Moderate	465 mmHg (9 psig)	620 mmHg (12 psig)	775 mmHg (15 psig)	Maximum	Moderate
<21	21-200	>200																
103 mmHg (2 psig)	207 mmHg (4 psig)	310 mmHg (6 psig)	Minimum															
258 mmHg (5 psig)	414 mmHg (8 psig)	569 mmHg (11 psig)	Moderate															
465 mmHg (9 psig)	620 mmHg (12 psig)	775 mmHg (15 psig)	Maximum															
Occlusion Override of Downstream Occlusion Pressure Settings	Available (Enable) Unavailable (Disable) (When enabled, clinicians can change the occlusion limit settings. Setting remains in effect until the pump is powered off.)	Enabled																

Table 6-3 Options Specific to a PERSONALITY Feature Set — continued

Option	Available Settings	Factory Settings
Number of Auto Restarts after a Downstream Occlusion	0 to 9	5
Secondary Callback Alert	Available (Enable) Unavailable (Disable) (When enabled, pump sounds an alert tone when secondary infusion ends and primary infusion resumes)	Disabled
Alert Off Interval	1 second to 7 seconds (Allows adjustment of time between audible tones.)	4 seconds
Alarm Off Interval	1 second to 7 seconds (Allows adjustment of time between audible tones.)	1 second
Auto Lock	Available (Enable) Unavailable (Disable)	Disabled
Label Library Feature	Available (Enable) Unavailable (Disable)	Enabled
Select Available Labels	(YES) Enable (NO) Disable Note: Individual labels can be enabled or disabled using the Library Setup soft key. Note: If labels have been configured using the COLLEAGUE GUARDIAN feature, those labels must also be enabled in each PERSONALITY feature set in order for them to be accessible when that PERSONALITY feature set is selected for use.	All Predefined Labels Enabled (YES) Custom Labels Disabled (NO)

Label Library

The pump's Label Library contains 64 predefined labels and allows up to 436 custom labels to be programmed by facility-authorized personnel. Individual labels can then optionally be programmed with default program limits using the COLLEAGUE GUARDIAN feature, and then enabled or disabled for each PERSONALITY feature set as appropriate for the needs of the facility.

Note: If a label is configured using the COLLEAGUE GUARDIAN feature, it is selectable from the COLLEAGUE GUARDIAN list and is not displayed in the Label Line list.

Predefined Labels

Table 6-4 is a list of the predefined medication labels and abbreviations available within the label library configuration setup.

Table 6-4 *Predefined Medication Labels*

Name	Abbreviation
Abciximab	ABCIXIMA
Alfentanil	ALFENTAN
Alteplase	ALTEPLAS
Aminophylline	AMINOPHY
Amiodarone	AMIODARO
Amrinone	AMRINONE
Atracurium	ATRACURI
Carboplatin	CARBOPLA
Carmustine	CARMUSTI
Cisatracurium	CISATRAC
Cisplatin	CISPLATI
Cyclophosphamide	CYCLOPHO
Diltiazem	DILTIAZE
Dobutamine	DOBUTAMN
Dopamine	DOPAMINE

Table 6-4 *Predefined Medication Labels — continued*

Name	Abbreviation
Doxorubicin	DOXORUBI
Eptifibatide	EPTIFIBA
Esmolol	ESMOLOL
Etoposide	ETOPOSID
Fentanyl	FENTANYL
Fluorouracil	FLUOROUR
Heparin Sodium	HEPARIN
Ifosfamide	IFOSFAMI
Isoproterenol	ISPROTER
Ketamine	KETAMINE
Labetalol	LABETALO
Lidocaine	LIDOCAIN
Magnesium Sulfate	MAGNESIU
Methohexital	METHOHEX
Methotrexate	METHOTRE
Midazolam	MIDAZOLA
Milrinone	MILRINON
Mivacurium	MIVACURI
Morphine Sulfate	MORPHINE
Naloxone	NALOXONE
Nicardipine	NICARDIP
Nitroglycerin	NITROGLY
Nitroprusside	NITROPRU
Norepinephrine	NOREPINE
Octreotide	OCTREOTI
Oxytocin	OXYTOCIN
Paclitaxel	PACLITAX

Table 6-4 *Predefined Medication Labels — continued*

Name	Abbreviation
Phenylephrine	PHENYLEP
Plicamycin	PLICAMYC
Procainamide	PROCAINA
Propofol	PROPOFOL
Prostaglandin E1	PROSTAGL
Rocuronium	ROCURONI
Sufentanil	SUFENTAN
Tirofiban	TIROFIBA
Vecuronium	VECURONI

Application Labels

Table 6-5 is a list of the predefined application labels and abbreviations available within the label library configuration setup.

Note: The COLLEAGUE GUARDIAN feature cannot be used with the application labels.

Table 6-5 *Predefined Application Labels*

Name	Abbreviation
Application Labels	
Antibiotic	ANTIBIOT
Arterial Line	ARTERIAL
Blood	BLOOD
Central Line	CENTRAL
Epidural	EPIDURAL
Irrigation	IRRIGAT
Keep Vein Open	KVO
Lipids	LIPIDS

Table 6-5 *Predefined Application Labels — continued*

Name	Abbreviation
Maintenance Line	MAINTENA
Subcutaneous	SUBCUTAN
Total Parenteral Nutrition	TPN
Umbilical Arterial Catheter	UAC
Umbilical Venous Catheter	UVC

Custom Labels

The pump allows programming of up to 436 custom labels in addition to the predefined label library. When the Label Library feature is enabled, the user can select from the predefined and custom labels. Custom labels appear in the list in alphabetical order.

See the *COLLEAGUE Pump Configuration Manual* or the *COLLEAGUE Guardian Configuration Tool User's Guide* for instructions on configuring custom labels.

Maintenance and Storage

This chapter provides information on the following topics:

- “Cleaning,” 7-1
- “Maintenance,” 7-2
- “Storage,” 7-6

Cleaning

! WARNING !

Do not allow fluid to enter the tubing channel or load wet tubing into the pump. Contact your Baxter Service Center for assistance immediately if fluid enters the tubing channel. The tubing channel should be cleaned as soon as possible by Baxter-trained, qualified personnel to minimize potential difficulties caused by fluid pooling and drying on the mechanism. Fluid in the tubing channel can also cause false Air In Line alarms. See “Authorized Service Centers,” 10-2.

CAUTION

Do not clean, disinfect, or sterilize any part of the pump by autoclaving or with ethylene oxide gas. Doing so may damage the pump and void the warranty. Only external parts of the pump should be disinfected.

CAUTION

Do not use the following chemicals on the pump, as they will damage the front panel: acetone, acetoaldehyde, ammonia, benzene, hydroxytoluene, methylene chloride, and ozone.

Note:

Do not cut the tubing to remove the administration set from the channel. If the tubing is cut, remove the slide clamp immediately.

Prior to cleaning, ensure that the pump is powered off, that it is disconnected from AC power, and that the cover is in place on the RS232 Communication Port.

When cleaning, take care to ensure the following:

- Do not submerge the pump in liquid or allow the pump to sit in a puddle of liquid.
- Do not spray solutions directly onto nor into the pump.
- Do not saturate the pump.
- Do not use cotton swabs to clean the tubing channel as it is possible for the swabs to leave lint.

Clean the exterior of the pump after each use. Holding the pump upright, clean all surfaces using a premade wipe or a sparingly dampened soft cloth. If the cloth has been saturated, it must be wrung out prior to contact with the pump. A foam tipped sponge (Baxter part number TWTX740B) can be used to clean contaminants from corners, recessed areas, the channel slot, the slide clamp prism, the Manual Tube Release area, and seams.

Use any of the approved cleaning solutions listed below:

- 70.0% Isopropanol (IPA alcohol).
- 2 - 7% Sodium hypochlorite (bleach) diluted with 90% water to create a 10% bleach solution.
- 3.0% Hydrogen peroxide. Final concentration is 3%
- 1.7 g Sodium dichloroisocyanurate tablets. Use blood concentration or 10 tablets per liter of water = 10,000 PPM chlorine.
- Isopropanol 17.2%; Disobutylphenoxyethyl dimethyl benzyl ammonium chloride 0.28%. No further dilution.
- Isopropanol 55.0%, Alkyl*dimethyl benzyl ammonium chloride 0.25%, Alkyl*dimethyl ethylbenzyl ammonium chloride 0.25%.

Allow the pump to dry completely after cleaning before bagging.

Maintenance

Preventive Maintenance

The table below contains a schedule of basic maintenance tasks that should be performed on the pump. If the pump cannot be cleaned using the basic methods described earlier or components are missing or damaged, discontinue use and notify the appropriate Baxter-trained, qualified personnel. To contact Baxter for service or repair, see “Service Information,” 10-2.

For information on calibration, see the *COLLEAGUE Pump Global Service Manual*.

Check	Action
Perform as required but recommended after every use.	
Housings	Clean housing and front panel as recommended in the cleaning instructions in this section. Check for cracks and large dents.
Labels	Clean as recommended in the cleaning instructions. Check for scratches, cuts or obliterated words.
Power cord	Check the cord and connectors for cracks and damage. Do not use the pump if the connectors appear damaged.
Feet	Verify that the feet are free of cuts or deterioration and that they are securely fastened.
Rear housing	Verify that there are no loose or missing parts and that connectors and accessories are undamaged.
Contrast and Volume controls	Verify that both controls are undamaged and rotate freely.
Pole clamp knob and mechanism	Verify that knob operates freely throughout range of motion. Ensure that pads are present; check that the pump remains attached to IV pole.
Main Batteries	Pump should be plugged in whenever possible to maintain batteries at full charge. If batteries are not at full charge, recharge them by plugging the pump into a 100-120 VAC, 50/60 Hz or 220-240 VAC, 50/60 Hz power outlet for at least 12 hours. Check that the plug icon is illuminated during this time. See “Storage,” 7-6 for information on charging batteries for pumps in storage.
Perform as required but recommended every 12 months.	
Entire pump	Schedule operational checkout by Baxter-trained, qualified personnel or authorized service representative.

Battery Care

CAUTION

When charging the batteries, ensure the room temperature is between 15° C (59° F) to 30° C (86° F) to minimize charge time and maximize battery life.

The pump can be battery-powered in emergency situations and while transporting patients. The battery charge icon is displayed at all times in the upper left part of the screen. When the pump is unplugged and operating on battery power, the battery charge icon alternates with the Plug In icon, and the approximate battery operating time is displayed below the icon.

Charge the battery for at least 12 uninterrupted hours or until the battery operating time displayed under the battery charge icon in the upper left part of the screen is 3h 15m (for triple channel pumps) or 4h 00m (for single channel pumps). A complete charge may take longer than 12 hours.

The following information is intended to assist in optimizing the performance and service life of the pump's primary batteries. Routine battery care enhances battery performance, which helps ensure optimal pump performance.

Battery Service Life

! WARNING !

It is necessary to perform the recommendations for periodic checking and replacement of batteries.

Service life is the time a battery can be discharged and recharged to useful capacity. While lead-acid batteries are rechargeable, in the course of use they gradually lose the chemical electrolytes needed to recharge them to useful capacity. When a battery reaches the point in its service life where it is no longer capable of being recharged to a level adequate to operate the device, it must be replaced.

Factors that most commonly affect battery life are as follows:

- Frequency of discharge/recharge
The more often a battery is cycled, the sooner it requires replacement.
- Depth of discharge
The more often a lead-acid battery is discharged to a low battery or deep discharge state, the sooner it requires replacement.
- Leaving batteries in a discharged condition
If the batteries have been discharged, do not store the pump without first fully charging the batteries. The batteries may be permanently damaged if the pump is stored unplugged with discharged batteries for more than two weeks.

If a **Damaged Battery! Service Now** alarm occurs during power on, the pump cannot be used. See “About the Damaged Battery Alarm,” 8-8.

If the **Damaged Battery! Service Now** alert occurs during pump operation, do not use the pump on battery power. Keep the pump plugged into an AC power outlet and have it serviced as soon as possible so the batteries can be replaced. Do not use the pump for transport.

When the pump detects that the battery has been charged and discharged 195 or more times, the **Battery Approaching End of Life** alert occurs. Do not use the pump on battery power, and have it serviced as soon as possible so the batteries can be replaced.

Optimizing Battery Service Life

Ensuring the following procedures are a part of routine device use can optimize battery service life:

- Connect pumps to AC power at all times except in the event of AC power loss or short-term portable operation.
- Store pumps plugged into AC power to maintain the battery charge whenever possible.
- If the batteries have been discharged, do not store the pump without first fully charging the batteries. The batteries may be permanently damaged if the pump is stored unplugged with discharged batteries for more than two weeks.
- To help prolong battery life, never store the pump unplugged. See “Storage,” 7-6 for more information.
- Notify Central Supply or other appropriate departments as soon as a pump is removed from patient use so that it can be cleaned and the batteries can be recharged.
- Recharge a pump that is in the **DEPLETED Battery - Plug In Now** alert condition or the **NO Battery - Plug In Now** alarm condition for a minimum of 12 uninterrupted hours or until the battery operating time displayed under the battery charge icon in the upper left part of the screen is 3h 15m (for triple channel pumps) or 4h 00m (for single channel pumps). A complete charge may take longer than 12 hours.

Charging the Batteries

CAUTION

When charging the batteries, ensure the room temperature is between 15° C (59° F) to 30° C (86° F) to minimize charge time and maximize battery life.

When a **NO BATTERY - Plug in Now** alarm occurs plug the pump in immediately. Do not use the pump on battery power until the batteries have been fully recharged. Charge the batteries for at least 12 uninterrupted hours or until the battery operating time displayed under the battery charge icon in the upper left part of the screen is 3h 15m (for triple channel pumps) or 4h 00m (for single channel pumps). A complete charge may take longer than 12 hours.

The batteries are charging whenever the pump is plugged into a 100-120 VAC, 50/60 Hz or 220-240 VAC 50/60 Hz outlet, regardless of whether the pump is on or off. Whenever the batteries are charging, the Plug icon is lit. Store the pump plugged in to maintain batteries at full charge. See “Storage,” 7-6 and the *COLLEAGUE Pump Global Service Manual* for more battery information.

In general, the more often the batteries are discharged and recharged, the sooner they will need to be replaced. **Batteries should only be replaced by Baxter-trained, qualified personnel. Always replace both batteries at the same time, with two new batteries manufactured within three months of one another.**

Call your authorized Baxter Service Center (see “Service Information,” 10-2) to obtain replacement batteries (Baxter service part number UBAT1010A, Baxter factory part number 5009480001, Yuasa part numbers NP2-12 and MD12020).

Disposing of Used Batteries

The pump’s sealed lead acid batteries should be disposed of in accordance with local regulations.

Storage

! WARNING !

It is necessary to perform the recommendations for periodic checking and replacement of batteries.

CAUTION

The pump should never be stored unplugged and powered on.

Store the pump under the following conditions to maximize battery life.

- Store the pump with its power cord plugged into an AC outlet to maintain the batteries at full charge whenever possible. Doing so will maintain the batteries at full charge.
- If the batteries have been discharged, do not store the pump without first fully charging the batteries. The batteries may be permanently damaged if the pump is stored unplugged with discharged batteries for more than two weeks.
- To help prolong battery life, never store the pump unplugged.
- If pumps must be stored unplugged, fully recharge their batteries every two months.
- Recharge spare batteries every four months. Do not use batteries after four months if the recharge has not been performed as recommended.
- The storage temperature range for the pump is -15° C (5° F) to 40° C (104° F). Ideal storage temperature is normal room ambient conditions of 23° C (73.4° F). Storing the pump at higher temperatures may damage the batteries.

- Pumps or batteries stored at temperatures below freezing (0° C or 32° F) must be warmed to room temperature before using the pump.
- When unpackaged, ensure the pump is stored in a clean and dry (20-95% RH, non-condensing) environment to safeguard against prolonged exposure to dust and moisture. In conditions falling outside the Environmental Operating Limits (see “Technical Specifications,” 9-1), Baxter recommends that the pump be repackaged in the original shipping materials.

Troubleshooting

Alert, Alarm, and Failure Messages

This chapter lists all alert and alarm messages in alphabetical order.

Active alert, alarm, and failure messages are displayed on the status line at the top of the Main Display (Figure 8-1). An abbreviated form of the message is also shown on the pump module display.

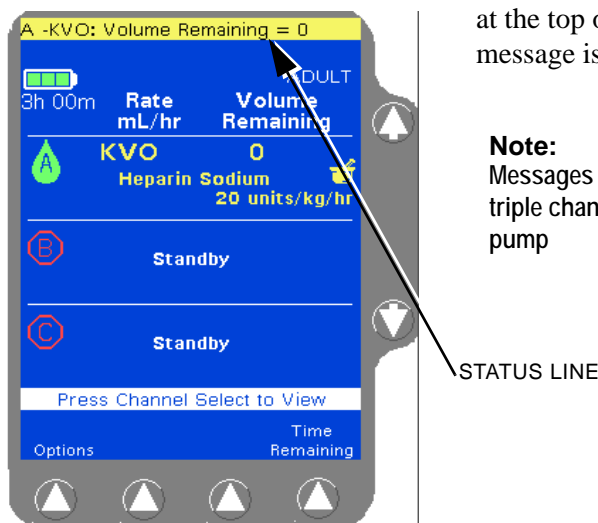

Note:
Messages on a
triple channel
pump

For triple channel pumps, two status lines may be displayed. Channel identifiers (A, B, C) accompany the messages.

Figure 8-1 Main Display Status Line

Restoring a Darkened Screen

When the pump is running on battery power, the main display will go dark 60 seconds after the last key press to conserve power. Pressing the **Back Light** key (upper right corner of the pump) will restore illumination to the main display and turn on the pump module display(s) for 60 seconds.

Troubleshooting Failures

Overview

A failure overrides all alerts and alarms and indicates a potential problem was detected with the pump. A device or channel failure automatically stops any infusion. When a failure is detected, a **Failure XXX:YY...Y** message (where **XXX** = failure code and **YY...Y** = additional diagnostic data) is displayed in the status line of the Main Display. **FAILURE** is displayed on the affected pump module display, the **ALARM LED** continuously lights, and a failure tone sounds.

Channel Failure mode allows retrieval of volume and infusion history from the pump in the event of a pump module failure.

Device Failure

Device failures affect all infusions running on the device. When a device failure has occurred, follow the directions below:

1. **Close the regulating clamp on the administration set.** Unload the administration set (see Step 5 on page 8-3 for single channel pumps or Step 4 on page 8-6 for triple channel pumps).
2. Request a replacement pump immediately.
3. Cycle power on the pump by powering off and then powering on again. Do this only once.
4. Based on the result, do one of the following:
 - If the failure code recurs after the pump is turned back on, stop using the pump.
 - If the failure code does not recur after the pump is turned back on, re-load the administration set into the same channel, open the regulating clamp, and continue using the pump.
5. Monitor the pump until replacement pump arrives and transfer any infusions to the replacement pump as soon as it is clinically safe.
6. Have the failed pump serviced as soon as possible according to instructions provided in the *COLLEAGUE Pump Global Service Manual*.

Channel Failures (Single Channel Pumps)



Figure 8-2 Channel Failure Status Line Display

Figure 8-2 shows the Channel Failure alarm message on a single channel pump. The procedure for responding to a channel failure is provided below.

Note: Failures occurring on battery power

If the pump is running on battery power and a failure occurs, the failure message may not be displayed on the pump module display. The failure will be displayed on the Main Display, the ALARM LED will light, and the audible tone will occur.

Note: Using Manual Tube Release

Use Manual Tube Release only when the Tube Loading Mechanism is NOT functioning, or if a channel failure occurs.

Note: 803:07 Failure Code

If Failure Code 803:07 occurs, ensure that the slide clamp has been removed from the pump. Do not cut the tubing to remove the administration set from the channel. If the tubing is cut, remove the slide clamp immediately.

! WARNING !

While the pump automatically closes the keyed slide clamp, always close the regulating clamp on the administration set before loading or removing the administration set from the pump.



Figure 8-3 Channel Failure Pop-up Message

1. Access the programming screen from the Main Display if necessary by pressing the **Primary** or **Secondary** soft key. The parameters for the infusion in progress when the channel failed are displayed (see Figure 8-3 for an example). Record the parameters so the infusion can be continued on another pump if necessary.
2. Request a replacement pump immediately.
3. Perform Step 4 or Step 5 as appropriate:
4. If the tube loading mechanism is open, **close the regulating clamp on the administration set** and remove the set. Press the **Done** soft key. The channel is now shown as **Out Of Service** (Figure 8-4). The pump cannot be used to deliver infusions, but the **Volume History** key can be used to retrieve history information. Continue to Step 6.
5. If the channel fails with the tube loading mechanism in the “closed” position:
 - **Close the regulating clamp on the administration set.** Press the **Open** key. If the mechanism opens, remove the set.
 - If the mechanism does not open (or if the device has been powered off due to depleted batteries), use the Manual Tube Release to remove the set (see “Using the Manual Tube Release,” 4-79).

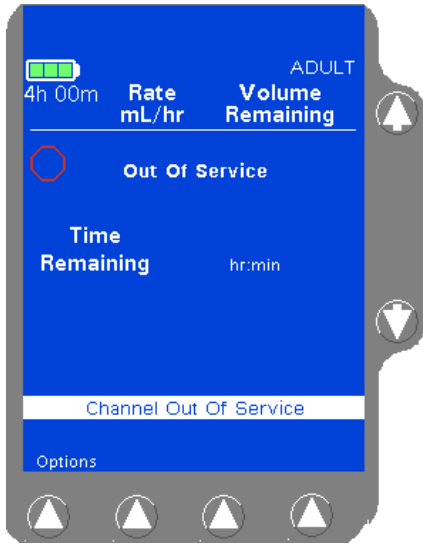

Figure 8-4 Channel Out of Service Display

6. Press the **Done** soft key. The Main Display shows that the pump is out of service (Figure 8-4). The pump cannot be used to deliver infusions, but the **Volume History** key can be used to retrieve history information.
7. Cycle power on the pump by powering off and then powering on again. Do this only once.
8. Based on the result, do one of the following:
 - If the failure code recurs after the pump is turned back on, stop using the pump.
 - If the failure code does not recur after the pump is turned back on, re-load the administration set into the same channel, open the regulating clamp, and continue using the pump.
9. Monitor the pump until replacement pump arrives and transfer any infusions to the replacement pump as soon as it is clinically safe.
10. Have the failed pump serviced as soon as possible according to instructions provided in the *COLLEAGUE Pump Global Service Manual*.

Note:
Using Manual
Tube Release

If the Manual Tube Release is used following a channel failure to remove the administration set, the pump cannot be powered off until the Manual Tube Release has been reset.

If three unsuccessful attempts are made to reset the Manual Tube Release, a channel failure will occur and the pump will be unavailable for use until the Manual Tube Release is reset and the pump is powered off and back on.

Channel Failures (Triple Channel Pump)

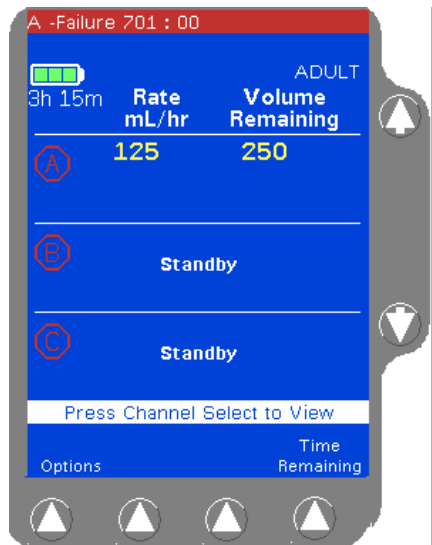

Figure 8-5 Channel Failure Status Line Display

Channel failures affect a specific pump channel on the device. Infusions running on unaffected channels can be completed before removing the device from service. Figure 8-5 shows the Channel Failure alarm message. The procedure for responding to a channel failure is provided below.

Note:
Failures occurring on battery power

If the pump is running on battery power and a failure occurs, the failure message may not be displayed on the pump module display. The failure will be displayed on the Main Display, the ALARM LED will light, and the audible tone will occur.

Note:
Using Manual Tube Release

Use Manual Tube Release only when the Tube Loading Mechanism is NOT functioning, or if a channel failure occurs. If the Manual Tube Release is used when the pump channel is functioning normally, programming either of the remaining pump channels is not possible until the Manual Tube Release is reset.

Note:
803:07 Failure Code

If Failure Code 803:07 occurs, ensure that the slide clamp has been removed from the pump. Do not cut the tubing to remove the administration set from the channel. If the tubing is cut, remove the slide clamp immediately.

! WARNING !

While the pump automatically closes the keyed slide clamp, always close the regulating clamp on the administration set before loading or removing the administration set from the pump.



Figure 8-6 Channel Failure Pop-up Message

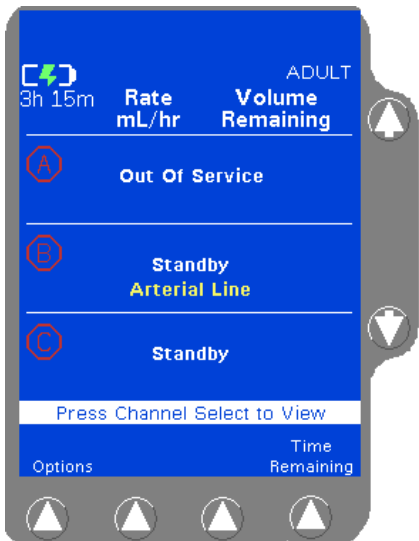

Figure 8-7 Channel Failure Display

1. Press the appropriate **Channel Select** key. The parameters for the infusion in progress when the channel failed are displayed (see Figure 8-6 for an example). Record the parameters so the infusion can be continued on one of the other pump channels if necessary.
2. Perform Step 3 or Step 4 as appropriate:
3. If the tube loading mechanism is open, **close the regulating clamp on the administration set** and remove the set. Press the **Done** soft key. The channel is now shown as **Out Of Service** (Figure 8-6). Continue to Step 5.
4. If the channel fails with the tube loading mechanism in the “closed” position:
 - **Close the regulating clamp on the administration set.** Press the **Open** key for the failed pump channel. If the mechanism opens, remove the set.
 - If the mechanism does not open (or if the device has been powered off due to depleted batteries), use the Manual Tube Release to remove the set (see “Using the Manual Tube Release,” 4-79).
5. Press the **Done** soft key. The Main Display shows that the pump channel is out of service (Figure 8-7).
6. Allow any infusions running on the other pump channels to complete. The failed pump channel cannot be used to deliver infusions, but the **Volume History** key can be used to retrieve history information if desired.
7. Remove the pump from service and have it inspected by Baxter-trained, qualified personnel as soon as possible.

Note:
Using Manual Tube Release

If the Manual Tube Release is used following a channel failure to remove the administration set, the pump cannot be powered off until the Manual Tube Release has been reset.

If three unsuccessful attempts are made to reset the Manual Tube Release, a channel failure will occur and the channel will be unavailable for use until the Manual Tube Release is reset and the pump is powered off and back on.

Troubleshooting Alarms

Overview

Alarm conditions automatically stop the infusion(s) on the affected channel(s) and require immediate attention before the infusion(s) can be restarted.

An alarm condition displays a message in the Main Display's status line(s) and on the affected pump channel display. In addition, the red ALARM LED on the affected pump channel flashes and the alarm tone sounds. To silence the alarm tone for two minutes, press the **Alarm Silence** key.

An alarm will override an existing alert condition. To silence the alert tone for two minutes, press the **Alarm Silence** key.

Note: How alarms appear on the pump module display Selected label information may alternate with an abbreviation of the alarm message shown in the status line on the pump module display. Alternating messages are represented in this chapter by using a "/" mark between the pump module message and the label. For example, AIR/label indicates that the AIR alarm message alternates with the selected label on the pump module display.

Note: Alarm/Alert messages on triple channel pumps Channel-specific alarm and alert messages include the appropriate channel identifier (A, B, or C) in the main display status line on a triple channel pump. In this chapter, the channel identifiers are represented by the letter "X" example: X-ADV AIR (where X = A, B, or C).

The same message appears on single channel pumps without the Channel Identifier.

About the Damaged Battery Alarm

Note: If a **Damaged Battery! Service Now** alarm occurs during power on, the pump cannot be used.

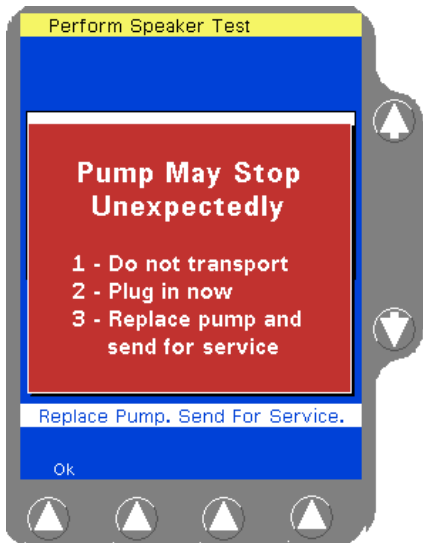

Figure 8-8 Power On Screen with Damaged Battery Alarm Pop-up

The **Damaged Battery! Service Now** alarm occurs if the pump software detects that one or more of the conditions listed below is true during power up.

- The battery's history data was cleared inadvertently because of an external event.
- The battery voltage falls below 10.4 volts.
- The battery has been charged and discharged more than 200 times.

If this alarm occurs at power on, a pop-up appears warning that the pump may stop unexpectedly (Figure 8-8). Press the **Ok** soft key to clear the pop-up. The pump cannot be used. The alarm can only be cleared by replacing the batteries.

Turn the pump off, plug it in, and have it serviced as soon as possible so its batteries can be replaced. Use a different pump to deliver the infusion.

The pop-up shown in Figure 8-8 will also appear if the pump detects that the battery is damaged when powered on but not in use. If the pump detects that the battery is damaged during an infusion, the **Damaged Battery! Service Now** alert will occur, and the pump will continue infusing. See page 8-18 for more information about the **Damaged Battery! Service Now** alert.

Plug the pump in immediately. Do not attempt to use the pump on battery power or to transport the patient. Transfer the patient's infusions to another pump and have the damaged battery replaced by authorized service personnel as soon as possible.

Troubleshooting Air Detected Alarms

! WARNING !

Pulling or tugging on the administration set tubing between the pump channel and the patient may cause false Air Detected alarms, which will cause the pump to stop infusing. In order to reduce the potential for this situation to occur:

- First, select an appropriate length administration set.
- Before loading the set into the pump, position the keyed slide clamp at an appropriate location along the tube segment to ensure that there is adequate length of tubing between the patient and the pump to reduce tugging on the set.
- Lastly, ensure there is sufficient slack in the tubing between the distal end of the tubing channel and the patient to prevent tube tugging during activities such as moving the patient from one bed to another, or transportation of the patient from one facility location to another.

In order to avoid false alarms, the pump should never be placed on the bed alongside the patient.

! WARNING !

There is a risk of under-infusion if a downstream occlusion occurs while an air bubble, 1.9 cm (0.75 inch) or larger, is within the pumping mechanism between the upstream occlusion sensor and the downstream occlusion sensor, but not under the Air in Line sensor. In this particular situation, the pump may not detect air in the line or the downstream occlusion and may continue to pump without delivering medication or alarming.

When the pump detects an air bubble larger than the configured setting, an Air Detected alarm will occur. The status line displays **Air Detected** and the pump module displays **AIR/Label**.

! WARNING !

To properly remove air from the administration set, follow the recommended actions below.

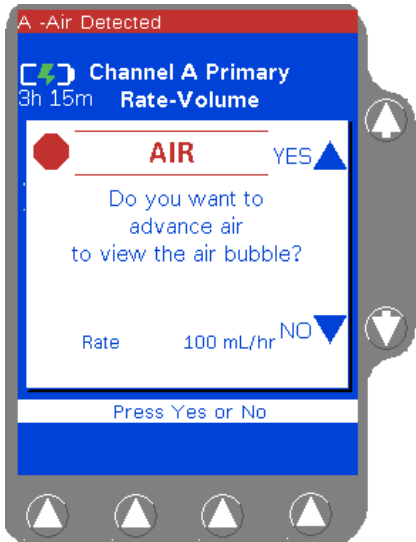

Figure 8-9 Advance Air Pop-up

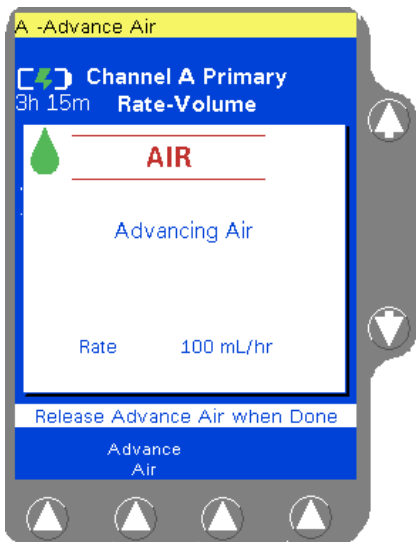

Figure 8-10 Advancing Air

Recommended Action:

1. When an air alarm occurs:
 - for single channel pumps: the **Advance Air** pop-up window is automatically displayed.
 - for triple channel pump: press the **Channel Select** key to access the appropriate programming screen. The **Advance Air** pop-up window is displayed (Figure 8-9).

Press the ↑ key next to the **Yes** label for pump-assisted viewing of the detected air.

If the volume to be infused is less than 0.4 mL when air is detected, the pop-up also displays the message **Switchover may occur during Air Advance**, indicating that the pump may switchover to the primary infusion or KVO mode.

If pump-assisted viewing of the detected air is not desired, press the ↓ key (**No**) to manually purge the air. Remove the administration set as described in “Unloading the Administration Set,” 4-78 and remove the air from the tubing in accordance with the recommended practice of the facility. When manual purge has been completed, go to Step 5 of these instructions.

Pressing the **No** key and then unloading the set to manually purge the air causes the pump to exit the Advance Air screen.

2. Press and hold the **Advance Air** soft key. The pump pumps at the currently programmed rate to advance the air bubble (Figure 8-10). An **Advance Air** alert occurs while the advance air mode is in use.

Note: The pump continues to pump at the programmed rate until the **Advance Air** soft key is released.

When the pump detects fluid, **FLUID** is displayed (Figure 8-11).

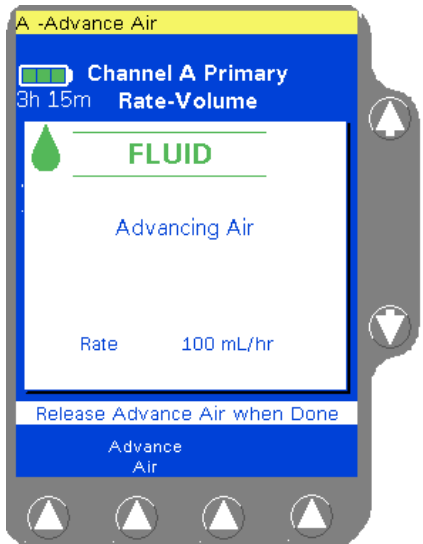

Figure 8-11 Fluid Detected

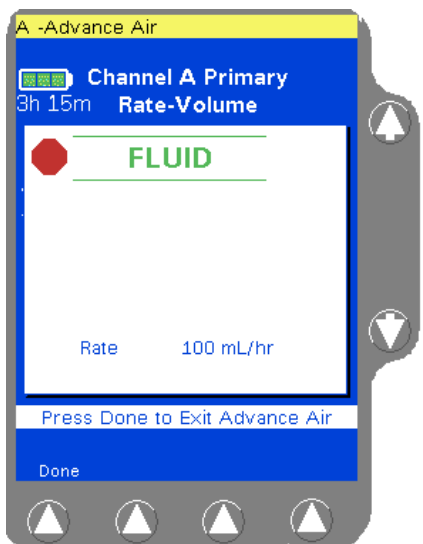

Figure 8-12 Fluid Detected, Advance Air Stopped

3. Release the **Advance Air** soft key. The pump stops infusing (Figure 8-12).
4. Press the **Done** soft key. The **Air Detected** alarm is reset. Visually inspect the air and follow the facility's procedures for manually removing the air.
5. After the air has been removed, the infusion may be restarted. Press the **Primary** or **Secondary** soft key to access the appropriate programming screen and then press the **START** key.

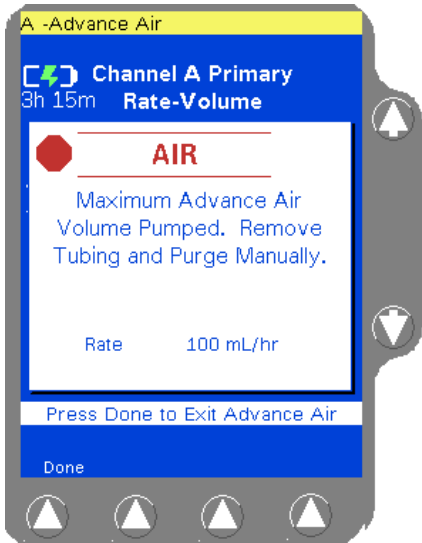

Figure 8-13 Maximum Volume Pumped

Note:
Advance Air Limit

If 0.4 mL of air is advanced using the **Advance Air** soft key, the **Advance Air Limit** screen is displayed (Figure 8-13) and the **Advance Air** soft key is disabled. Remove the administration set from the pump and remove the air manually.

! WARNING !

While the pump automatically closes the keyed slide clamp, always close the regulating clamp on the administration set before loading or removing the administration set from the pump.

Troubleshooting Other Alarms

Table 8-1 shows how to troubleshoot all other pump alarms. The left column of the table shows the alarm messages displayed on the Main Display and on the pump module display. The middle column describes the cause of the alarm, and the right column recommends the action to take to address the alarm.

Note:
Alarm/Alert messages on triple channel pumps

Channel-specific alarm and alert messages include the appropriate channel identifier (A, B, or C) in the main display status line on a triple channel pump.

In this chapter, the channel identifiers are represented by the letter "X" example: X-ADV AIR (where X = A, B, or C).

The same message appears on single channel pumps without the Channel Identifier.

Table 8-1 Troubleshooting Alarm Messages

Alarm Message	Cause	Recommended Action
<p>X - Close Regulating Clamp</p> <p>PATIENT---->>>></p>	<p>One of the following occurred while an administration set was loaded:</p> <ul style="list-style-type: none"> • The Open key was pressed. • The Manual Tube Release was opened. 	<ul style="list-style-type: none"> • Close the regulating clamp on the administration set and remove the keyed slide clamp from the slot. • Reload the set, if desired.
<p>Damaged Battery! Service Now</p> <p>(no pump module alert message)</p>	<p>This message occurs as an alarm if the pump detects one or more of the following conditions during power up, or during operation without an infusion running:</p> <ul style="list-style-type: none"> • The battery's history data was cleared inadvertently because of an external event. • The battery voltage falls below 10.4 volts. • The battery has been charged and discharged more than 200 times. 	<p>When a Damaged Battery! Service Now alarm occurs during power on, the pump cannot be used.</p> <ul style="list-style-type: none"> • Plug the pump in immediately. • Do not attempt to use the pump on battery power or to transport the patient. • Transfer the patient's infusions to another pump and have the damaged battery replaced by authorized service personnel as soon as possible <p>See "About the Damaged Battery Alarm," 8-8 for more information.</p>
<p>X - Downstream Occlusion</p> <p>DWN OCCL/label</p>	<p>A closed clamp, stopcock, clogged filter or other occlusion is preventing fluid flow between the pump and patient.</p>	<ul style="list-style-type: none"> • Correct the problem causing the occlusion. • Restart the infusion: <ul style="list-style-type: none"> • for single channel pumps: press the Primary or Secondary soft key to access the appropriate programming screen and then press the START key. • for triple channel pumps: press the appropriate Channel Select key to access the appropriate programming screen and then press the START key. <p>Note: When the pump is configured with the Auto Restart feature on, the pump channel can automatically restart if the occlusion is removed within one minute after detection. If any pump key is pressed during a Downstream Occlusion alarm, Auto Restart will be disabled.</p>
<p>X - Incomplete Primary Program</p> <p>X - Incomplete Secondary Program</p> <p>STOPPED</p>	<p>The START key was pressed prior to completing programming.</p>	<p>Enter the missing parameter value(s) and press the Confirm Primary or Confirm Secondary soft key followed by the START key.</p>

Table 8-1 Troubleshooting Alarm Messages — continued

Alarm Message	Cause	Recommended Action
<p>NO BATTERY - Plug in Now</p> <p>BATTERY/DEPLETED</p>  <p><i>Figure 8-14 NO BATTERY Alarm Pop-up</i></p>	<p>The batteries are depleted and infusions have stopped. The pump must be plugged into AC power before infusions may be restarted. After 5 minutes in this alarm state (Figure 8-14), the pump will shut down.</p>	<p>To clear the alarm, plug into an AC power source immediately. A pop-up is displayed, instructing not to unplug the pump. Press the Ok soft key to clear the pop-up and resume the infusion using AC power.</p> <ul style="list-style-type: none"> To resume infusions on single channel pumps: press the START key. To resume infusions on triple channel pumps: press the Channel Select key(s), then press the START key. <p>Do not use the pump on battery power until the battery charge icon indicates that the batteries have fully charged</p> <p>If infusions are complete, power off the pump by pressing the ON/OFF CHARGE key twice and allow the batteries to recharge fully.</p> <p>See “Battery Charge Alerts and Alarms,” 4-10 for more information.</p>
<p>Panel Lockout Button Stuck</p> <p>STK KEY (on all channels)</p>	<p>Without an infusion programmed, the PANEL LOCKOUT button has been pressed for longer than 5 seconds.</p>	<p>Do one of the following as appropriate:</p> <ul style="list-style-type: none"> Release the button. Relocate any objects next to the pump that may be pressing the button. Ensure the pump’s power cord is not wrapped around the pump in such a way as to press the button. <p>If unresolved for more than 50 seconds, a failure will result.</p>
<p>X - Primary Out of Range</p> <p>X - Secondary Out of Range</p> <p>STOPPED</p>	<p>A programming value outside the programmable range allowed has been entered. This alarm occurs as soon as the Confirm Primary or Confirm Secondary soft key or the START key is pressed.</p>	<ul style="list-style-type: none"> Verify the appropriate values have been entered. Press the Confirm Primary or Confirm Secondary soft key as appropriate, if required, and the START key to begin the infusion. If alarm recurs, the value range available in the current PERSONALITY feature set may not be broad enough to accommodate the entries. Using the Options menu, check the current PERSONALITY feature set configuration.
<p>X - Reset Manual Tube Release</p> <p>RESET/label</p>	<p>The Manual Tube Release was activated.</p>	<p>Close the regulating clamp on the administration set, remove the administration set, and reset the Manual Tube Release. See “Using the Manual Tube Release,” 4-79 for details.</p>

Table 8-1 Troubleshooting Alarm Messages — continued

Alarm Message	Cause	Recommended Action
Stuck Key Detected STK KEY (on all channels)	Without an infusion running, a key on the pump’s front panel has been pressed for longer than 5 seconds.	Do one of the following as appropriate: <ul style="list-style-type: none"> • Release the key. • Relocate any objects next to the pump that may be pressing a key. If unresolved for more than 50 seconds, a failure will result.
Temperature Too High TEMP HGH/label	Operating or administration set temperature is outside the design limits.	Move the pump, administration set, and solution to a suitable temperature environment, then restart the infusion.
Temperature Too Low TEMP LOW/label	Operating or administration set temperature is outside the design limits.	<ul style="list-style-type: none"> • Move the pump, administration set, and solution to a suitable temperature environment, then restart the infusion. • Allow cold solutions or sets to warm to the operating temperatures before use.
X - Tube Loading in Progress LOADING	The administration set was not fully loaded in the tubing channel when the START key was pressed.	Wait for the loading action to complete, then press the START key.
X - Tube Misloaded PATIENT---->>>>	<ul style="list-style-type: none"> • The administration set is improperly loaded. • The administration set was not fully removed from the tubing channel. • A hardware problem may have occurred. 	<ul style="list-style-type: none"> • Close the regulating clamp on the administration set and remove the administration set. See “Unloading the Administration Set,” 4-78. • If alarm occurs again, a hardware problem may exist. Take the pump out of service and have it inspected by Baxter-trained, qualified personnel.
X - Tube Not Loaded NO TUBE	The administration set was not loaded prior to pressing the START key.	<ul style="list-style-type: none"> • Press the Open key to reset the alarm. • Load the administration set, then press the START key.
X - Unconfirmed Primary Program X - Unconfirmed Secondary Program STOPPED	The START key was pressed prior to confirming programming information.	Press the Confirm Primary or Confirm Secondary soft key followed by the START key. Note: An Unconfirmed Primary Program alarm can occur when attempting to start a secondary infusion if a primary infusion has been programmed but not confirmed . To clear the alarm, press the Primary soft key, then the Confirm Primary soft key. Press the Secondary soft key to continue with the secondary infusion.

Table 8-1 Troubleshooting Alarm Messages — continued

Alarm Message	Cause	Recommended Action
X - Upstream Occlusion UPOCCL/label	A closed clamp, obstruction, or kink in the administration set is preventing fluid flow between the source container and the pump.	<ul style="list-style-type: none"> • Ensure the complete insertion of the spike into the source container. • Inspect the administration set above the pump for closed clamps or kinks. • Ensure that BURETROL administration sets or source containers are vented. • Restart the infusion: <ul style="list-style-type: none"> • for single channel pumps: press the Primary or Secondary soft key to access the appropriate programming screen and then press the START key. • for triple channel pumps: press the Channel Select key to access the appropriate programming screen and then press the START key.

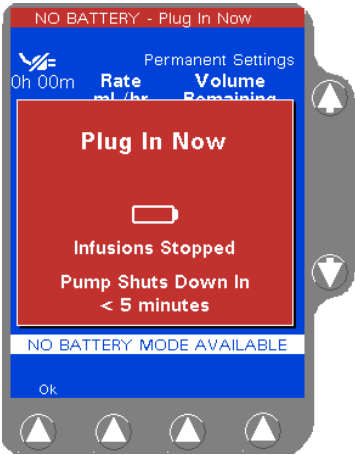
Troubleshooting Alerts

Alerts call attention to conditions that may require user intervention without stopping the infusion. During an alert condition, the pump displays a message in the Main Display's status line and on the pump module display. In addition, the yellow ALERT LED on the appropriate pump channel lights and an alert tone sounds.

Note:
How alerts appear on the pump module display

Selected label information may alternate with an abbreviation of the alert message shown in the status line on the pump module display. Alternating messages are represented in this chapter by using a “ / ” mark between the pump module message and the label.
For example, KVO/label indicates that the KVO alert message alternates with the selected label on the pump module display.

Note:
Alarm/Alert messages on triple channel pumps

Channel-specific alarm and alert messages include the appropriate channel identifier (A, B, or C) in the main display status line on a triple channel pump.

In this chapter, the channel identifiers are represented by the letter "X"
example: X-ADV AIR (where X = A, B, or C).

The same message appears on a single channel pump without the Channel Identifier.

To silence the alert tone for two minutes, press the **Alarm Silence** key.

Table 8-2 Troubleshooting Alert Messages

Alert Message	Cause	Recommended Action
X-Advance Air ADV AIR	The pump's Advance Air feature is being used to move an air bubble through the tubing	See "Troubleshooting Air Detected Alarms," 8-9.
Battery Approaching End of Life (no pump module alert message)	The pump's battery requires replacement because it is nearing the end of its life. The alert occurs when the pump detects that the battery has been charged and discharged 195 or more times. This alert occurs even if the pump is plugged in.	Do not use the pump on battery power. Send the pump for servicing as soon as possible so its battery can be replaced.
X - Changing Secondary Program (xx.x or xxx) mL/hr (where xx.x or xxx = infusion rate)	The secondary rate is being changed during a secondary infusion.	Finish the secondary data entry and press START key.
X - Changing Primary Program (xx.x or xxx) mL/hr (where xx.x or xxx = infusion rate)	The primary rate or dose is being changed during a primary infusion.	Finish the primary data entry and press START key.
X - Channel Stopped STOPPED	The pump is powered on and the infusion is not running.	Complete remaining programming steps and press the START key or power off the pump.
Charge Progress: X of 20 (no pump module alert message)	The pump's battery is charging.	Allow the battery to recharge fully.

Table 8-2 Troubleshooting Alert Messages — continued



Alert Message	Cause	Recommended Action
<p>Confirm Power Off</p> <p>PWR OFF?</p>	<p>The ON/OFF CHARGE key was pressed once. To ensure that the user intends to power off the pump, a second key press is required for confirmation.</p>	<p>To power off the pump, press the ON/OFF CHARGE key a second time.</p> <p>Press the Return soft key to return to the previous screen.</p>
<p>Damaged Battery! Service Now</p> <p>SEND TO/SERVICE</p>  <p><i>Figure 8-15 Damaged Battery Alert</i></p>	<p>While infusing, the pump cannot detect battery status, or detects a battery failure (Figure 8-15).</p> <p>This message occurs as an alert if one or more of the following occur during pump operation:</p> <ul style="list-style-type: none"> • The battery's history data was cleared inadvertently because of an external event. • The battery voltage falls below 10.4 volts. • The battery has been charged and discharged more than 200 times. 	<ul style="list-style-type: none"> • Press the Ok soft key to close the pop-up. • Plug the pump into an AC power outlet. • Switch the patient's infusions to another pump as soon as possible. • Do not use the pump for transport. • Send the pump for servicing. <p>This alert can be silenced but not cleared.</p> <p>See “Battery Charge Alerts and Alarms,” 4-10 for more information.</p>
<p>DEPLETED Battery - Plug In Now</p> <p>BATTERY/DEPLETED</p>  <p><i>Figure 8-16 DEPLETED Battery Alert Pop-up</i></p>	<p>The pump's battery has been discharged to a level where it is depleted and less than 5 minutes of battery time remains (Figure 8-16).</p> <p>The pump will enter the NO BATTERY - Plug in Now alarm (see Table 8-1), and all infusions will stop, unless it is plugged in immediately.</p>	<p>Plug the pump in immediately.</p> <p>A pop-up is displayed, instructing that the pump be left plugged in so the battery can recharge sufficiently. Press the Ok soft key to acknowledge the pop-up and continue using the pump on AC power.</p> <p>Allow the batteries to recharge fully.</p> <p>See “Battery Charge Alerts and Alarms,” 4-10 for more information.</p>

Table 8-2 Troubleshooting Alert Messages — continued

Alert Message	Cause	Recommended Action
<p>X - Dose out of Range LIMITS</p>	<p>The COLLEAGUE GUARDIAN feature was used to configure dose limits for the currently selected label, and the currently programmed dose is outside of the predefined dose limits.</p>	<p>Do one of the following as appropriate:</p> <ul style="list-style-type: none"> • Press Accept Dose to proceed with the infusion as programmed. Overriding the dose limits will be recorded in the pump’s event history. • Press Cancel Dose to return to the programming screen, then reprogram the infusion.
<p>X - Incomplete Primary Program</p> <p>X - Incomplete Secondary Program</p> <p>(no pump module alert message)</p>	<p>With a primary infusion running on the channel, the START key was pressed:</p> <ul style="list-style-type: none"> • prior to completing secondary infusion programming, or • prior to completing a change to the rate or dose. 	<p>Enter the missing parameter value(s) and press the Confirm Primary or Confirm Secondary soft key followed by the START key.</p>
<p>Limited Battery - Plug in Now</p> <p>(no pump module alert message)</p>  <p>Figure 8-17 Limited Battery Alert Pop-up</p>	<p>The pump is operating on battery power. Approximate infusion time remaining on the batteries is displayed and decrements until the pump is plugged in (Figure 8-17).</p>	<p>If the pump cannot be plugged in, press the Ok soft key to mute the audible alert tone and allow the pump to run on the batteries.</p> <p>Plug the pump into AC power as soon as possible to maintain battery charge.</p> <p>See “Battery Charge Alerts and Alarms,” 4-10 for more information.</p>
<p>Lithium Battery Low BATT LOW</p>	<p>The charge remaining in the lithium battery is low.</p>	<p>Remove the pump from service and have Baxter-trained, qualified personnel replace the lithium battery.</p>

Table 8-2 Troubleshooting Alert Messages — continued

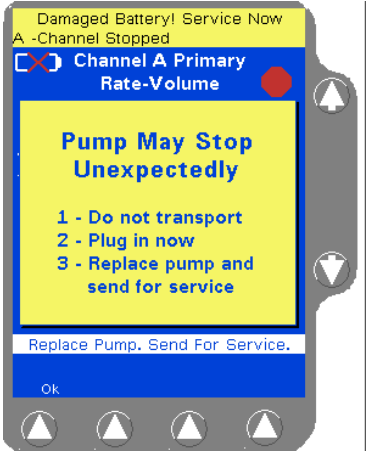
Alert Message	Cause	Recommended Action
<p>LOW Battery - Plug in Now BATT LOW</p>  <p>Figure 8-18 LOW Battery Alert Pop-up</p>	<p>The charge remaining in the batteries has 30 minutes of infusion time left (Figure 8-18). The time remaining shown on the Main Display decrements if the pump is not plugged in.</p>	<p>Plug the pump into an AC power source as soon as possible.</p> <p>See “Battery Charge Alerts and Alarms,” 4-10 for more information.</p>
<p>X -KVO: Volume Remaining = 0 KVO=x.x/label (where x.x = infusion rate)</p>	<p>The volume to be infused has decremented to zero and the pump is infusing at the KVO rate (or the programmed rate, whichever is lower).</p>	<p>Do one of the following as appropriate:</p> <ul style="list-style-type: none"> • Prepare a new infusion • For triple channel pumps, stop the channel and place it in Standby mode • Power off the pump.
<p>X - Priming PRIMING</p>	<p>The Prime soft key is being pressed.</p>	<p>Release the Prime soft key after the set is primed.</p>
<p>X - Programming Secondary (xx.x or xxx) mL/hr (where xx.x or xxx = primary infusion rate)</p>	<p>Programming of a secondary infusion is occurring while the primary infusion is running. The alert is intended as a reminder to complete the secondary program and start the secondary infusion, if appropriate.</p>	<p>Complete the secondary program and press the START key.</p>

Table 8-2 Troubleshooting Alert Messages — continued

Alert Message	Cause	Recommended Action
<p>X - Rate out of Range LIMITS</p>	<p>The COLLEAGUE GUARDIAN feature was used to configure rate limits for the currently selected label, and the currently programmed infusion is outside of the predefined rate limits.</p>	<p>Do one of the following as appropriate:</p> <ul style="list-style-type: none"> • Press Accept Rate to proceed with the infusion as programmed. Overriding the rate limits will be recorded in the pump’s event history. • Press Cancel Rate to return to the programming screen, then reprogram the infusion.
<p>Release Panel Lockout Button STK KEY (on all channels)</p>	<p>The PANEL LOCKOUT button on the rear of the pump has been pressed for longer than 5 seconds.</p>	<p>Do one of the following as appropriate:</p> <ul style="list-style-type: none"> • Release the button. • Relocate any objects next to the pump that may be pressing the button. • Ensure the pump’s power cord is not wrapped around the pump in such a way as to press the button.
<p>Running on Battery - Plug in Now (no pump module alert message)</p>	<p>The pump is running on battery power</p>	<p>Plug the pump into AC power as soon as possible to maintain battery charge.</p> <p>See “Battery Charge Alerts and Alarms,” 4-10 for more information.</p>
<p>X - Secondary Callback at HH:MM CALLBACK</p>	<p>The secondary infusion has been completed and the pump has switched over to the programmed primary rate or KVO, whichever is less. The secondary callback feature is enabled.</p>	<p>Press the Alarm Silence key or any programming key to cancel the alert.</p>
<p>Stuck Key Detected STK KEY (on all channels)</p>	<p>A key on the pump’s front panel has been pressed for longer than 5 seconds.</p>	<p>Do one of the following as appropriate:</p> <ul style="list-style-type: none"> • Release the key. • Relocate any objects next to the pump that may be pressing a key.

Table 8-2 Troubleshooting Alert Messages — continued

Alert Message	Cause	Recommended Action
X - Unconfirmed Primary Program X - Unconfirmed Secondary Program (no pump module alert message)	With a primary infusion running, the START key was pressed prior to confirming programming information.	Press the Confirm Primary or Confirm Secondary soft key followed by the START key.

Technical Specifications

Pump Specifications

Component	Description
Device Type	Baxter product code 2M91617A Single Channel Shuttle Volumetric Infusion Pump Baxter product code 2M91637A Triple Channel Shuttle Volumetric Infusion Pump
Administration Sets	Standard Baxter administration sets equipped with keyed slide clamps. See “Recommended Administration Sets,” 4-15.
AC Power Requirements	100/120 VAC 50/60 Hz or 220-240 VAC 50/60 Hz.
Leakage Current	Less than 300 microamperes earth leakage (tested per UL 60601-1).
External Fuses	1.6 amp Type T (time delay) 250V.
Power Cord	Approximately 2.7 m (9 feet) long with integrally molded plug.
Battery Supply System	For single channel pumps: Fully charged new batteries typically provide approximately 4 hours of operation at 100 mL/hr. Battery run time is dependent on the channel flow rate and device/clinician interaction. For triple channel pumps: Fully charged new batteries typically provide approximately 2 hours of operation with all three channels running at 100 mL/hr. Battery run time is dependent on the channel flow rate and device/clinician interaction. Internal charge system recharges batteries whenever pump is connected to an AC outlet. See “Battery Care,” 7-3 for more information about the batteries.

Component	Description										
Range of Programmable Flow Rates	<p>Primary Infusion</p> <ul style="list-style-type: none"> • 0.1 to 99.9 mL/hr in 0.1 mL/hr increments • 1 to 1200 mL/hr in 1 mL/hr increments <p>Secondary Infusion</p> <ul style="list-style-type: none"> • 0.1 to 99.9 mL/hr in 0.1 mL/hr increments • 1 to 500 mL/hr in 1 mL/hr increments <p>Note: Rate limits can be configured for values less than those stated above.</p> <p>! WARNING !</p> <p>There may be periods of no flow for flow rates less than or equal to 1mL/hr.</p>										
Volume to be Infused	<ul style="list-style-type: none"> • 0.1 to 99.9 mL in 0.1 mL increments (micro). • 1 to 9999 mL in 1 mL increments (macro). <p>Note: Volume to be infused limits can be configured for values less than those stated above.</p>										
Patient Weight Range (for dose modes based on patient weight)	<p>Programmable from 0.2 to 99.9 kg in 0.1 kg increments. Programmable from 100 to 600 kg in 1 kg increments.</p> <p>(Programmable from 0.44 to 99.99 lb in 0.01 lb increments. Programmable from 100 lb to 1322 lb in 1 lb increments).</p> <p>Note: For each PERSONALITY feature set, patient weight range (in kg) and the units for patient weight entry (lb or kg) can also be configured within the limits specified above.</p>										
KVO	0.1 to 5 mL/hr in 0.1 mL increments (configurable option) or programmed rate, whichever is less.										
Priming Rate	500 mL/hr. Note: To be used only when the administration set is not connected to patient.										
Advance Air Rate to Advance an Air Bubble	At the same rate programmed for the current primary or secondary infusion.										
Air Bubble Setting	<p>The air bubble setting is a configurable option.</p> <p>The air sensor measures the accumulated amount of air detected over an amount of solution delivered. The amount of delivered solution depends on the programmed bubble size. The air alarm is triggered for a single air bubble greater than the set threshold or an accumulation of air greater than the threshold. The alarm threshold and accumulation volumes are given in the table below.</p> <table border="1" data-bbox="544 1528 1144 1732"> <thead> <tr> <th data-bbox="544 1528 868 1564">Air Bubble Setting</th> <th data-bbox="868 1528 1144 1564">Accumulation Volume</th> </tr> </thead> <tbody> <tr> <td data-bbox="544 1564 868 1606">25 microliters</td> <td data-bbox="868 1564 1144 1606">0.83 mL</td> </tr> <tr> <td data-bbox="544 1606 868 1648">50 microliters</td> <td data-bbox="868 1606 1144 1648">1.67 mL</td> </tr> <tr> <td data-bbox="544 1648 868 1690">100 microliters</td> <td data-bbox="868 1648 1144 1690">3.33 mL</td> </tr> <tr> <td data-bbox="544 1690 868 1732">150 microliters</td> <td data-bbox="868 1690 1144 1732">5.00 mL</td> </tr> </tbody> </table>	Air Bubble Setting	Accumulation Volume	25 microliters	0.83 mL	50 microliters	1.67 mL	100 microliters	3.33 mL	150 microliters	5.00 mL
Air Bubble Setting	Accumulation Volume										
25 microliters	0.83 mL										
50 microliters	1.67 mL										
100 microliters	3.33 mL										
150 microliters	5.00 mL										

Component	Description												
Nominal Downstream Occlusion Level for Alarm	<p>Downstream Occlusion Alarm sensitivity is a configurable option.</p> <p>Rate range in mL/hr</p> <table border="0" style="width: 100%; text-align: center;"> <tr> <td style="width: 33%;"><21</td> <td style="width: 33%;">21-200</td> <td style="width: 33%;">>200</td> </tr> <tr> <td>103 mmHg (2 psig)</td> <td>207 mmHg (4 psig)</td> <td>310 mmHg (6 psig)</td> </tr> <tr> <td>258 mmHg (5 psig)</td> <td>414 mmHg (8 psig)</td> <td>569 mmHg (11 psig)</td> </tr> <tr> <td>465 mmHg (9 psig)</td> <td>620 mmHg (12 psig)</td> <td>775 mmHg (15 psig)</td> </tr> </table> <p>Minimum Moderate Maximum</p> <p>Note: At the Minimum setting, the pump will be more sensitive to changes in downstream occlusion pressure. At this setting, the Downstream Occlusion alarm may occur more frequently. At the Maximum setting, the pump will be less sensitive to changes in downstream occlusion pressure. At this setting, the Downstream Occlusion alarm may occur less frequently.</p>	<21	21-200	>200	103 mmHg (2 psig)	207 mmHg (4 psig)	310 mmHg (6 psig)	258 mmHg (5 psig)	414 mmHg (8 psig)	569 mmHg (11 psig)	465 mmHg (9 psig)	620 mmHg (12 psig)	775 mmHg (15 psig)
<21	21-200	>200											
103 mmHg (2 psig)	207 mmHg (4 psig)	310 mmHg (6 psig)											
258 mmHg (5 psig)	414 mmHg (8 psig)	569 mmHg (11 psig)											
465 mmHg (9 psig)	620 mmHg (12 psig)	775 mmHg (15 psig)											
Auto Restart	Allows the pump to automatically restart if an occlusion is relieved within approximately one minute after detection as long as no keys are pressed. This configuration option allows 0 to 9 restarts before manual intervention is required.												
Delay Start	Infusion parameters may be entered and the pump programmed to delay the start of the programmed infusion for up to 23 hours. The infusion will start automatically when the programmed start time is reached.												
Size	<p>Single channel pump is approximately 259 x 197 x 203 mm (10.2" H x 7.75" W x 8.0" D)</p> <p>Triple channel pump is approximately 353 x 197 x 203 mm (13.88" H x 7.75" W x 8.0" D)</p> <p>Does not include mounting clamp knob or power cord.</p>												
Weight	<p>Single channel pump is approximately 5.5 kg (12.1 lbs) including mounting clamp.</p> <p>Triple channel pump is approximately 7.9 kg (17.5 lbs) including mounting clamp.</p>												
Environmental Operating Limits	15°C to 38°C (59°F to 100°F), 20% to 95% Relative Humidity non-condensing, 70 – 106 kPa Barometric Pressure.												

Component	Description
Environmental Storage and Transport Limits	Transport: -29°C to 57°C (-20°F to 135°F), 20% to 85% Relative Humidity non-condensing, 50 – 106 kPa Barometric Pressure. Storage: -15°C to 40°C (5°F to 104°F), 20% to 95% Relative Humidity non-condensing, 70 – 106 kPa Barometric Pressure. See “Storage,” 7-6 for additional information.
Accessories	Syringe Adapter (Baxter product code 2D0300). COLLEAGUE GUARDIAN Configuration Tool (Baxter product code 2M9541). COLLEAGUE DL2 Event History Download Application (Baxter product code 2M9530). Note: Accessories may not be available for use in all countries.
Ground Impedance	Less than 0.2 ohms (tested per UL 60601-1).
Solution Container Height	Pump will operate at all programmable flow rates with a solution container height ranging from -500 to +508 mm (-19.68 to +20.0 inches). Container height is measured from the patient’s heart to the top of the fluid level in the source container.
Solution Viscosity	Pump will operate at all programmable flow rates with a solution viscosity ranging from 0.69 cP to 10.12 cP.

Interfaces

Configuration Transfer Cable

Configuration data can be copied directly from one COLLEAGUE CXE pump to another (or from one COLLEAGUE 3 CXE pump to another) using a Configuration Transfer cable (Baxter product code 2M8155).

The cable is attached to the Communications Port located on the rear of the pump (Figure 2-3). Configuration data transfers must be performed by an authorized healthcare professional. See the *COLLEAGUE Pump Global Service Manual* for detailed instructions and precautions for using this accessory.

The pump should not be connected to the patient when the Configuration Transfer Cable is attached; it is not suitable for use in the patient environment.

COLLEAGUE Communication Cable

The COLLEAGUE Communication Cable (Baxter part number AS3IS3002) is used with COLLEAGUE GUARDIAN Configuration Tool and the COLLEAGUE DL2 Event History Download Application, allowing for transfer of information between COLLEAGUE pumps and PCs. The cable is attached to the Communications Port located on the rear of the pump (Figure 2-3). See “Optional Pump Accessories,” 5-1 for more information on COLLEAGUE GUARDIAN Configuration Tool and the COLLEAGUE DL2 Event History Download Application.

The pump should not be connected to the patient when the COLLEAGUE Communication Cable is attached; it is not suitable for use in the patient environment.

External Monitoring

The External Monitoring feature is for Baxter diagnostic purposes only.

Recommended Practices

- Connections of this pump into the same patient line with other infusion systems or accessories may alter the system performance. Consult the infusion system or accessory manufacturer’s instructions for use before proceeding.
- To ensure that pump performance is maintained, annual inspections should be performed by Baxter-trained, qualified personnel in accordance with the *COLLEAGUE Pump Global Service Manual*.

In the U.S., annual inspections should be performed in accordance with The Joint Commission procedures.

Volumetric Accuracy of the System

The pump, using the administration sets identified in Chapter 4, maintains a volumetric accuracy as presented in Table 9-1.

Table 9-1 Volumetric Accuracy

Flow Rate Range	Accuracy [†]
0.1 to 0.9 mL/hr*	±10%
1.0 to 9.9 mL/hr**	±7%
10.0 to 1200 mL/hr**	±5%

* for any one-hour period or for 0.5 mL of delivery
 ** for any one-hour period over 72 hours
 † At least 90% of the observed values (95% confidence) will lie within the limits shown for the indicated settings.

Standard conditions:

- Ambient temperature: 23°C ±2°C
- Solution container height: +508 mm (+20 inches)
- Test solution: Distilled water
- Distal positive pressure: 0 mmHg
- Needle: 18 gauge
- Set Type: 2C8537S

Note that flow fluctuations can be caused by unusual conditions or combinations of conditions that may involve, but are not limited to, the following: position of the infusion container, fluid density, positive and negative pressure and the environment. Flow fluctuations are most likely to occur when the conditions mentioned above are exacerbated or when the pump is operated in conditions outside of its normal limits. See the Component Description Table on page 9-1 for details.

Table 9-2 documents deviations at 25 mL/hr from the accuracy stated above per the requirements of Sub-Clause 50.102 of IEC 60601-2-24 Part 2.

Table 9-2 Accuracy Information

Variable	Condition	Average Deviation	Maximum Deviation [†]
Back Pressure	-100 mmHg	4.1%	6.9%
	100 mmHg	-3.0%	5.8%
	300 mmHg	-6.9%	11.6%
Solution container height	-500 mm	-1.8%	3.8%
Temperature*	15°C	3.6%	8.2%
	38°C	-0.3%	3.0%
* not required by standard			
† At least 90% of the observed values (95% confidence) will lie below the limits shown for the indicated settings, represented as absolute values.			

Each deviation is tested by using the standard test condition holding the other variables constant.

! WARNING ! Rate accuracy can be affected by variations of fluid viscosity, fluid temperature, head height, or back pressure, or any combination thereof. Additional factors that may influence rate accuracy are administration set configuration and the duration of time the administration set is used.

Startup Graph Description

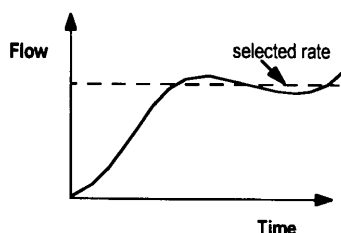

Figure 9-1 Startup Graph Example

The startup graph was developed in accordance with IEC 60601-2-24. The startup data shown in the graph illustrates the startup performance of the pump during the first 120 minutes of operation with a sampling period of 30 seconds.

A startup graph of flow versus time (Figure 9-1) illustrates initial stability with time. Even with the proper components and set up, the flow of any manufacturer’s pump may be erratic during the 120-minute startup period. Therefore, we have included the startup, or stabilization data. It should be noted that as the time interval over which accuracy is measured is lengthened, all pumps show considerable improvement in flow accuracy.

How Trumpet Curve Graphs are Interpreted

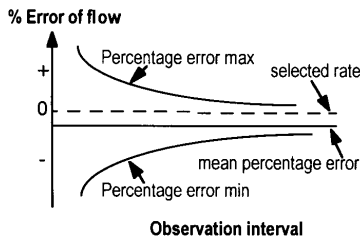

Figure 9-2 Trumpet Graph Example

The trumpet curve (Figure 9-2) provides a graphical view of the maximum deviation in flow rate from the programmed delivery rate for specific segments of delivery time. The horizontal axis does **not** represent elapsed delivery time, but rather acts as a graphical reference for selecting specific observation time intervals. The widest area of the trumpet curve (greatest deviation) reflects the smallest sampling intervals or observation windows. As the sizes of the sampling intervals increase (in minutes), the deviations in flow from the programmed delivery rate are reduced as the deviations are spread out over the longer periods of time. This results in the narrowing of the trumpet curve giving a more realistic representation of the pump's average flow rate accuracy over longer intervals of time.

For example, if you were to look at the maximum and minimum percentage error points corresponding to the 5-minute interval point on the Observation Interval axis, you would be looking at the average flow variance for any 5-minute period throughout the infusion.

Similarly, if you were to look at the 60-minute interval point on the Observation Interval axis, you would be looking at the average flow variance for any 60-minute period throughout the infusion.

How Trumpet Curve Graphs are Created

The trumpet curve graphs were developed in accordance with data collection and manipulation methods defined in IEC 60601-2-24.

The trumpet curve graphs were created in the following manner:

- Fluid from the pump is collected at the set flow rates over 72 hours.
- Every 30 seconds, the cumulative weight of the fluid is recorded.
- The data from the collection period are divided into observation or time windows and the flow rate accuracy is determined for each window.
- The maximum and minimum deviations from the set flow rate for various window sizes (2, 5, 11, 19, and 31 minutes) are plotted on a graph.
- These plotted points are connected to form the trumpet-shaped lines.
- Lines are then drawn to connect the plotted points to create the trumpet curve.

How Trumpet Curves can be Used

Trumpet curves can be important sources of information for the medical professional who must decide whether a certain infusion pump can be used with a particular drug. For example, when delivering a drug with a short half-life, very small deviations in flow over the course of an infusion would be desirable to ensure that the deviations in plasma level also remained small. The pump’s ability to deliver very closely to the programmed rate would ensure that the drug’s efficacy was being maintained. In this example, the medical professional would be wise to select a pump whose trumpet curve indicated a small or narrow range of deviations in flow rate.

Accuracy Tests

Tested per Sub-Clause 50.102 of IEC 60601-2-24 Part 2.

Tested at 1 mL/hr

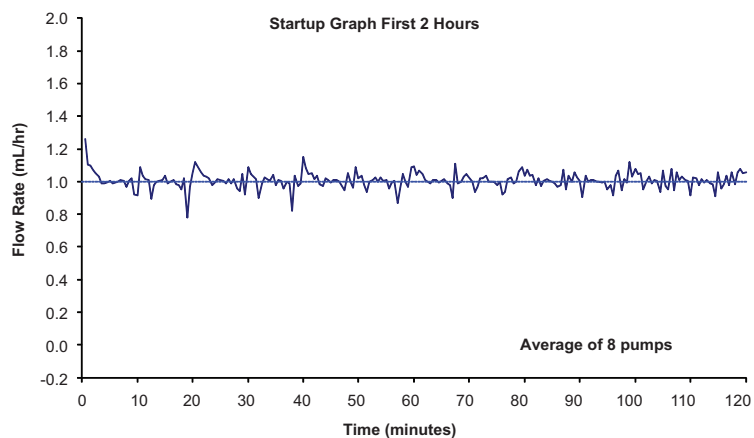

Figure 9-3 Delivery Startup, First Two Hours, 1 mL/hr

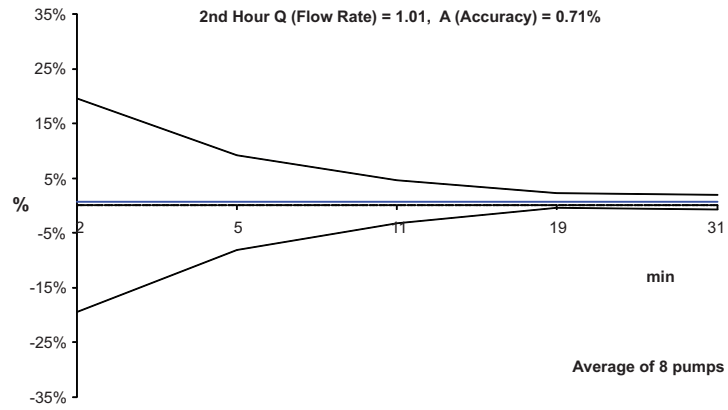

Figure 9-4 Trumpet Graph, 2nd Hour of Delivery, 1 mL/hr

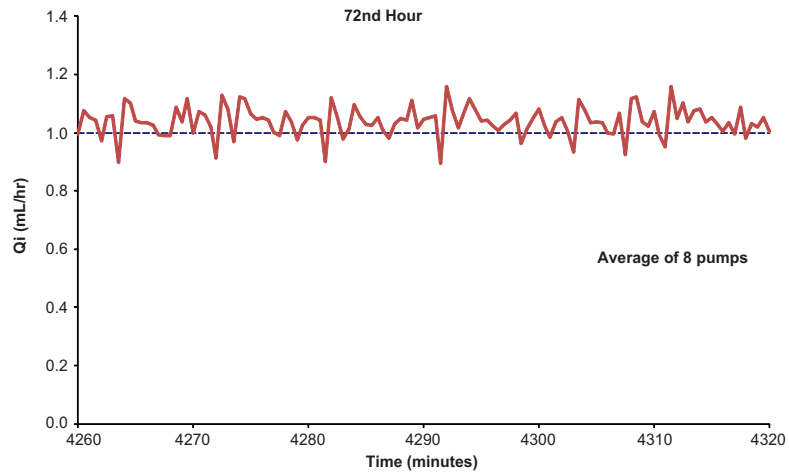

Figure 9-5 Flow Accuracy, 72nd Hour, 1 mL/hr

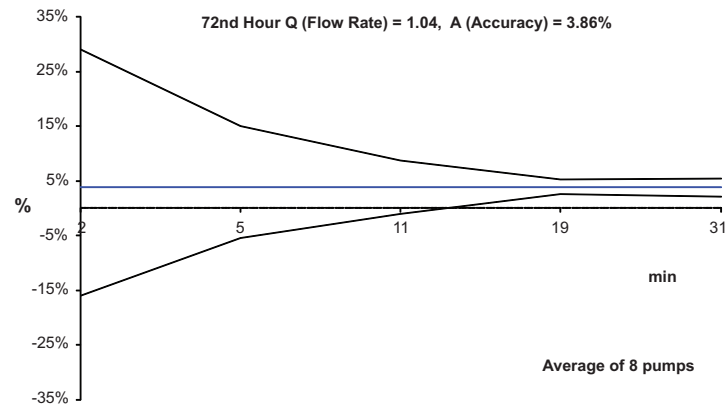

Figure 9-6 Trumpet Graph, 72nd Hour of Delivery, 1 mL/hr

Tested at 25 mL/hr

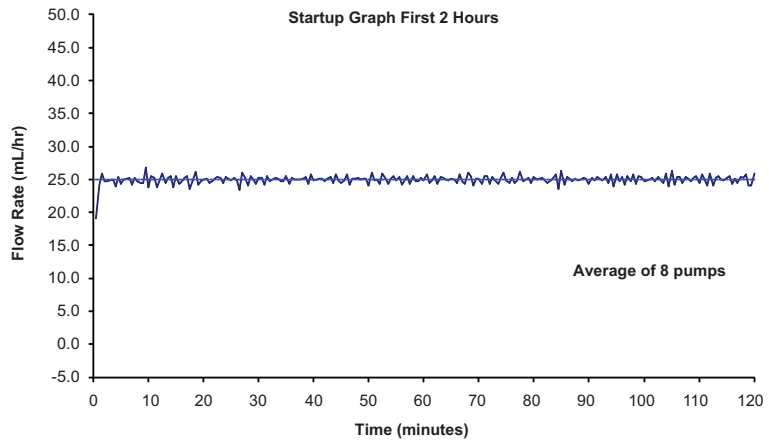

Figure 9-7 Delivery Startup, First Two Hours, 25 mL/hr

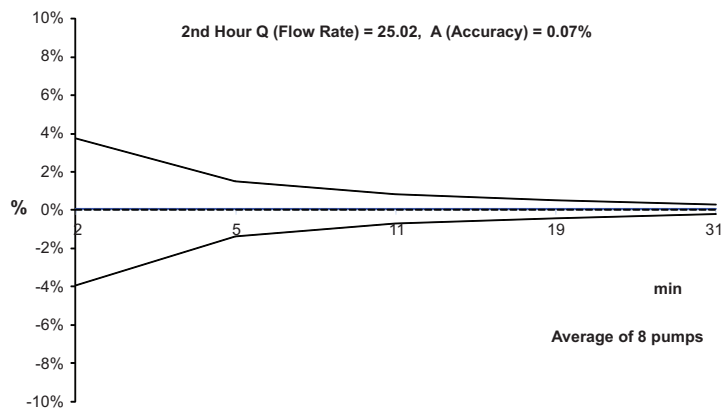

Figure 9-8 Trumpet Graph, 2nd Hour of Delivery, 25 mL/hr

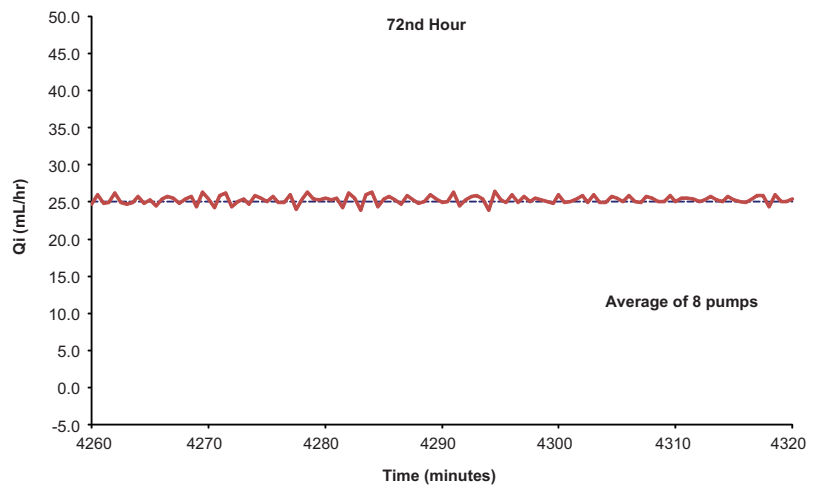

Figure 9-9 Flow Accuracy, 72nd Hour, 25 mL/hr

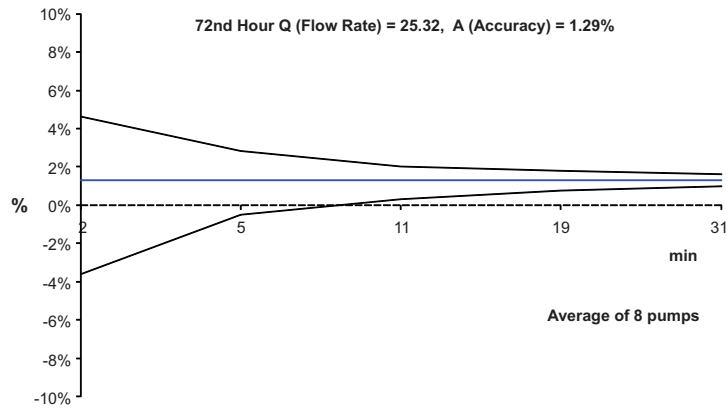

Figure 9-10 Trumpet Graph, 72nd Hour of Delivery, 25 mL/hr

1. Maximum Infusion Pressure Generated

The maximum infusion pressure prior to alarm activation is 931 mmHg (18 psi) at 25 mL/hr when tested per Sub-Clause 51.101a of IEC 60601-2-24 Part 2.

*At least 90% of the observed values (95% confidence) will lie below the limits shown for the indicated settings.

The information in the following tables represents laboratory testing conducted per Sub-Clause 51.101b of IEC 60601-2-24 Part 2.

2. Time to Detect Downstream Occlusions

Rate	Occlusion Alarm Pressure Setting	Typical Time to Alarm Activation	Maximum Time to Alarm Activation*
1 mL/hr	Minimum 103 mmHg (2 psig)	3 min 50 sec	7 min 47 sec
	Moderate 258 mmHg (5 psig)	9 min 42 sec	12 min 59 sec
	Maximum 465 mmHg (9 psig)	14 min 34 sec	19 min 26 sec
25 mL/hr	Minimum 207 mmHg (4 psig)	0 min 17 sec	0 min 23 sec
	Moderate 414 mmHg (8 psig)	0 min 27 sec	0 min 37 sec
	Maximum 620 mmHg (12 psig)	0 min 38 sec	0 min 48 sec

* At least 90% of the observed values (95% confidence) will lie below the limits shown for the indicated settings.

3. Bolus Volume Released After Downstream Occlusions Are Corrected

Rate	Occlusion Alarm Pressure Setting	Typical Bolus Volume	Maximum Bolus Volume*
1 mL/hr	Minimum 103 mmHg (2 psig)	0.1 mL	0.1 mL
	Moderate 258 mmHg (5 psig)	0.1 mL	0.2 mL
	Maximum 465 mmHg (9 psig)	0.2 mL	0.3 mL
25 mL/hr	Minimum 207 mmHg (4 psig)	0.1 mL	0.2 mL
	Moderate 414 mmHg (8 psig)	0.2 mL	0.2 mL
	Maximum 620 mmHg (12 psig)	0.3 mL	0.3 mL

* At least 90% of the observed values (95% confidence) will lie below the limits shown for the indicated settings.

4. Maximum Volume Under Single Fault Condition

1157 microliters $\pm 5\%$ delivered in 2 seconds.

Electromagnetic Compatibility Statement

This statement and the information provided in Tables 9-3 through 9-6 are required by IEC 60601-1-2, second edition. The tables can be used to identify the electromagnetic compatibility (EMC) standards the pump was subjected to, the minimum test level identified in the standard, the level that the pump meets and general guidance on the EMC environment. The pump is intended for use in the electromagnetic environment specified in the following tables. As with most microprocessor-based electronic products, the pump creates RF (radio frequency) energy as a side effect of its internal functions. The essential performance of the pump is volumetric accuracy.

Precautions should be taken to avoid exposing the pump to powerful sources of electromagnetic radiation such as MRI (magnetic resonance imaging).

Note that portable and mobile communications equipment such as cellular phones can affect medical electrical equipment such as the pump.

! WARNING !

The use of accessories and cables other than those specified in this manual, with the exception of cables sold by Baxter as replacement parts for internal components, may result in increased emissions, decreased immunity or may result in operation that is not within the constraints and parameters of the device.

Use only accessory equipment complying with the device's safety requirements; failure to do so may lead to reduced safety levels of the resulting system. Consideration relating to accessory choice shall also include:

- Use of the accessory in the patient vicinity
- evidence the safety certification of the accessory has been performed in accordance with the appropriate UL 60601-1 or IEC/EN 60601-1 harmonized national standard.

! WARNING !

The pump should not be used adjacent to or stacked with other electrical equipment. If adjacent or stacked use is necessary, the pump should be observed to verify normal operation in the configuration in which it will be used.

! WARNING !

As with all medical electronic equipment, care must be exercised to avoid exposing this device to powerful sources of electromagnetic interference. This device design has been tested to current U.S. and European standards and guidelines for medical devices. The device was not found to be affected adversely by these susceptibility tests and will perform safely. The device's emissions also were found to be acceptable. Using the pump near operating equipment which radiate high energy radio frequencies (such as electrosurgical/cauterising equipment, two-way radios, or cellular telephones) may cause false alarm conditions. If this happens, reposition the pump away from the source of interference; or turn off the pump and, if clinically necessary, manually regulate the flow with the regulating clamp according to your facility's guidelines.

Table 9-3 Guidance and Manufacturer's Declaration - Electromagnetic Emissions

The pump is intended for use in the electromagnetic environment specified below. The customer or the user of the pump should assure that it is used in such an environment.		
Emission Test	Compliance	Electromagnetic Environment - Guidance
RF emissions CISPR 11	Group 1	The pump uses RF energy only for its internal function. Therefore, its RF emissions are very low and are not likely to cause any interference in nearby electronic equipment.
RF emissions CISPR 11	Class A	The pump is suitable for use in all establishments, other than domestic and those directly connected to the public low-voltage power supply network that supplies buildings used for domestic purposes.
Harmonic emissions IEC 61000-3-2	Not applicable	
Voltage fluctuations/flicker emissions IEC 61000-3-3	Not applicable	

Table 9-4 Guidance and Manufacturer's Declaration - Electromagnetic Immunity

The pump is intended for use in the electromagnetic environment specified below. The customer or the user of the pump should assure that it is used in such an environment.			
Immunity Test	IEC 60601 Test Level	Compliance Level	Electromagnetic Environment - Guidance
Electrostatic discharge (ESD) IEC 61000-4-2	± 6 kV contact	± 8 kV contact (1)	Floors should be wood, concrete, or ceramic tile. If the floors are covered with synthetic material, the relative humidity should be at least 30%.
	± 8 kV air	± 15 kV air (1)	Pump may stop infusing and alarm at or above ± 15kV air.
Electrical fast transient burst IEC 61000-4-4	± 2 kV for power supply lines ± 1kV for input/output lines	± 2 kV for power supply lines	Mains power quality should be that of a typical commercial or hospital environment. Input/output lines are not used in the patient area.
Surge IEC 61000-4-5	± 1kV differential mode ± 2 kV common mode	± 1kV differential mode ± 2 kV common mode	Mains power quality should be that of a typical commercial or hospital environment.

Table 9-4 Guidance and Manufacturer's Declaration - Electromagnetic Immunity — continued

The pump is intended for use in the electromagnetic environment specified below. The customer or the user of the pump should assure that it is used in such an environment.			
Immunity Test	IEC 60601 Test Level	Compliance Level	Electromagnetic Environment - Guidance
Voltage dips, short interruptions and voltage variations on power supply input lines IEC 61000-4-11	<5% U_T (> 95% dip in U_T) for 0.5 cycle 40% U_T (60% dip in U_T) for 5 cycles 70% U_T (30% dip in U_T) for 25 cycles < 5% U_T (>95% dip in U_T) for 5 sec	<5% U_T (> 95% dip in U_T) for 0.5 cycle 40% U_T (60% dip in U_T) for 5 cycles 70% U_T (30% dip in U_T) for 25 cycles <5% U_T (> 95% dip in U_T) for 5 sec (2)	Mains power quality should be that of a typical commercial or hospital environment. If the user of the pump requires continued operation during power mains interruptions, it is recommended that the pump be powered from an uninterruptible power supply or a battery. User should always have battery installed per Operator's Manual.
Power frequency (50/60 Hz) magnetic field IEC 61000-4-8	3 A/m	3 A/m 400 A/m (1)	Power frequency magnetic characteristic of a typical location in a typical commercial or hospital environment. The pump functions normally when exposed to power frequency magnetic fields of 400 A/m.
Notes for Table 9-4			
Note 1	The pump was tested to the requirements of IEC 60601-1-2: 2001/A1:2004, Ed. 2 and IEC 60601-2-24: 1998.		
Note 2	Pump automatically transfers to battery operation if there is a loss of mains power.		
Note 3	U_T is the AC mains voltage prior to application of the test level.		

Table 9-5 Guidance and Manufacturer's Declaration - Electromagnetic Immunity- for Life-Supporting Equipment and Systems

The pump is intended for use in the electromagnetic environment specified below. The customer or the user of the pump should assure that it is used in such an environment.			
Immunity Test	IEC 60601 Test Level	Compliance Level	Electromagnetic Environment - Guidance
Conducted RF IEC 61000-4-6	3 Vrms 150 kHz TO 80 MHz outside ISM bands ^a	10 Vrms	Portable and mobile RF communications equipment should be used no closer to any part of the pump, including cables, than the recommended separation distance calculated from the equation applicable to the frequency of the transmitter. Recommended separation distance: $d = 0.35\sqrt{P}$
	10 Vrms 150 kHz to 80 MHz in ISM bands ^b	10 Vrms	
Radiated RF IEC 61000-4-3	10 V/m 80 MHz to 2.5 GHz	10 V/m	$d = 1.2\sqrt{P}$ 80 MHz to 800 MHz $d = 2.3\sqrt{P}$ 800 MHz to 2.5 GHz
	10 V/m 26 MHz to 1.0 GHz	10 V/m (3) (4)	
	20 V/m 80 MHz to 2.5 GHz	20 V/m (4) (5)	$d = 0.6\sqrt{P}$ 80 MHz to 800 MHz $d = 1.15\sqrt{P}$ 800 MHz to 2.5 GHz
			where P is the maximum output power rating of the transmitter in watts (W) according to the transmitter manufacturer and d is the recommended separation distance in meters (m). ^b Field strengths from fixed RF transmitters, as determined by an electromagnetic site survey ^c , should be less than the compliance level in each frequency range. ^d Interference may occur in the vicinity of equipment marked with the following symbol:
			

Notes for Table 9-5	
Note 1	At 80 MHz and 800 MHz, the higher frequency range applies.
Note 2	These guidelines may not apply in all situations. Electromagnetic propagation is affected by absorption and reflection from structures, objects, and people.
Note 3	The pump was tested to the requirements of IEC 60601-1-2: 2001/A1:2004, Ed. 2 and IEC 60601-2-24: 1998.
Note 4	For uncontrolled EMC environments such as road/ground ambulance, the pump may stop infusing and alarm at a level of 15 V/m or higher.
Note 5	The pump was tested to the requirements of IEC 60601-1-2: 2001/A1: 2004, Ed. 2, IEC 60601-2-24: 1998, and EN 1789: 2007.
(a)	The ISM (industrial, scientific and medical) bands between 150 kHz and 80 MHz are 6.765 MHz to 6.795 MHz; 13.553 MHz to 13.567 MHz; 26.957 MHz to 27.283 MHz; and 40.66 MHz to 40.70 MHz.
(b)	The compliance levels in the ISM frequency bands between 150 kHz and 80 MHz and in the frequency range 80 MHz to 2.5 GHz are intended to decrease the likelihood that mobile/portable communications equipment could cause interference if it is inadvertently brought into patient areas. For this reason, an additional factor of 10/3 is used in calculating the recommended separation distance for transmitters in these frequency ranges.
(c)	Field strengths from fixed transmitters, such as base stations for radio (cellular/cordless) telephones and land mobile radios, amateur radio, AM and FM radio broadcast, and TV broadcast cannot be predicted theoretically with accuracy. To assess the electromagnetic environment due to fixed RF transmitters, an electromagnetic site survey should be considered. If the measured field strength in the location in which the pump is used exceeds the applicable RF compliance level above, the pump should be observed to verify normal operation. If abnormal performance is observed, additional measures may be necessary, such as reorienting or relocating the pump.
(d)	Over the frequency range 150 kHz to 80 MHz, field strengths should be less than 3 V/m.

Table 9-6 Recommended Separation Distances Between Portable and Mobile RF Communications Equipment and the Pump - for Life-Supporting Equipment and Systems

The pump is intended for use in an electromagnetic environment in which radiated RF disturbances are controlled. The customer or the user of the pump can help prevent electromagnetic interference by maintaining a minimum distance between portable and mobile RF communications equipment (transmitters) and the pump as recommended below, according to the maximum output power of the communications equipment.

Rated Maximum Output Power of Transmitter (W)	Separation Distance According to Frequency of Transmitter (m)			
	150 kHz to 80 MHz outside ISM bands $d = 0.35\sqrt{P}$	150 kHz to 80 MHz in ISM bands $d = 1.2\sqrt{P}$	80 MHz to 800 MHz $d = 1.2\sqrt{P}$	800 MHz to 2.5 GHz $d = 2.3\sqrt{P}$
0.01	0.04	0.12	0.12	0.23
0.1	0.11	0.38	0.38	0.73
1	0.35	1.2	1.2	2.3
10	1.1	3.8	3.8	7.3
100	3.5	12	12	23
Rated Maximum Output Power of Transmitter (W)	N/A	N/A	80 MHz to 800 MHz $d = 0.6\sqrt{P}$	800 MHz to 2.5 GHz $d = 1.15\sqrt{P}$
0.01	N/A	N/A	0.06	0.12
0.1	N/A	N/A	0.19	0.36
1	N/A	N/A	0.6	1.2
10	N/A	N/A	1.9	3.6
100	N/A	N/A	6	12
Notes for Table 9-6				
For transmitters rated at a maximum output power not listed above, the recommended separation distance d in meters (m) can be estimated using the equation applicable to the frequency of the transmitter, where P is the maximum output power rating of the transmitter in watts (W) according to the transmitter manufacturer.				
Note 1	At 80 MHz and 800 MHz, the separation distance of the higher frequency range applies.			
Note 2	The ISM (industrial, scientific and medical) bands between 150 kHz and 80 MHz are 6.765 MHz to 6.795 MHz; 13.553 MHz to 13.567 MHz; 26.957 MHz to 27.283 MHz; and 40.66 MHz to 40.70 MHz.			
Note 3	An additional factor of 10/3 is used in calculating the recommended separation distance for transmitters in the ISM frequency bands between 150 kHz and 80 MHz and in the frequency range 80 MHz to 2.5 GHz to decrease the likelihood that mobile/portable communications equipment could cause interference if it is inadvertently brought into patient areas.			
Note 4	These guidelines may not apply in all situations. Electromagnetic propagation is affected by absorption and reflection from structures, objects, and people.			

Warranty and Service Information

Warranty

! WARNING !

This device should be repaired only by Baxter authorized service personnel or Baxter-trained hospital biomedical engineering personnel, using only Baxter recommended parts. There are risks associated with using anything other than Baxter recommended parts. Baxter will assume no responsibility for incidents which may occur if the product was not repaired in accordance with procedures authorized by Baxter.

Baxter warrants that the equipment shall be free from defects in material and workmanship when delivered to the original purchaser. Baxter's sole obligation shall be to repair or replace the product (excluding batteries), at Baxter's option and expense, for a period of one year following the date of initial delivery. The warranty period for batteries is limited to a period of six months following the date of initial delivery.

The warranty extends only to the original purchaser and is not assignable or transferable, and shall not apply to auxiliary equipment or disposable accessories. Using anything other than the recommended Baxter-designated IV administration sets with this pump will result in operation that is not within the constraints and parameters of the device. Baxter's warranty to repair or replace the product will be null and void if this product is used contrary to the directions for use contained in the labeling or if used with non-recommended sets. Baxter will assume no responsibility for incidents which may occur if the product is not used in accordance with product labeling.

THERE ARE NO OTHER WARRANTIES INCLUDING ANY IMPLIED WARRANTY AND ANY WARRANTY OF MERCHANTABILITY OR FITNESS FOR A PARTICULAR PURPOSE WHICH EXTEND BEYOND THE DESCRIPTION OF THE PRODUCT AND THOSE EXPRESSLY SET FORTH IN ITS LABELING. In no event shall Baxter be responsible for incidental, consequential or exemplary damages. Modification, alteration, recalibration, or abuse, and service by other than a Baxter authorized representative may void the warranty.

Service Information

While under Baxter's warranty, Service Agreement (optional), or lease agreement, the instrument must not be opened by unauthorized personnel.

Use only an authorized Baxter service provider for service and repair. For service and repair information for this product, call the authorized service center.

In the event that your pump needs to be returned for service, obtain a Return Authorization by calling 1-800-THE-PUMP or your local service center. Shipping costs for all pumps returned to Baxter shall be paid for by the customer. The pump must be packed in its original container or in another Baxter approved container that will provide adequate protection during shipment. To ensure prompt return, a Baxter authorized service representative must be notified before shipping any pump for repair. When calling for service, please be prepared to provide code number and serial number of the pump. A brief written description of the problem should be attached to the pump when it is returned for service.

Baxter will not be responsible for unauthorized returns or for pumps damaged in shipment due to improper packing.

Authorized Service Centers

In North America, call 1-800-THE-PUMP for service and repair information.

Elsewhere, visit www.baxter.com/baxter_worldwide.html or call your Baxter Customer Service representative to locate the nearest service center.

Quick Reference Guide

This quick reference guide is not intended to replace the complete user instructions provided elsewhere in this Operator's Manual. The user is advised to read and understand the complete operating instructions, including all warnings and cautions, prior to operating the COLLEAGUE CXE Volumetric Infusion Pump.

User Assistance Information

North America

For technical service of the COLLEAGUE pump call
1-800-THE-PUMP.

For product usage information or clinical questions, call Baxter
Medication Delivery Product Information Center at 1-800-933-0303.

Outside North America

Visit www.baxter.com/baxter_worldwide.html for contact information
or call your Baxter customer service representative to locate the nearest
service center.

Warnings and Cautions

Warnings

! WARNING !

The COLLEAGUE 3 CXE pump is intended for use in delivering multiple infusions to a single patient. Never use the pump to deliver infusions to more than one patient simultaneously.

! WARNING !

Do not use this pump in Linear Accelerator Radiation Therapy suites or Magnetic Resonance Imaging Suites.

! WARNING !

Do not use the COLLEAGUE pump in hyperbaric chambers.

! WARNING !

Do not use the COLLEAGUE pump with Extracorporeal Membrane Oxygenation (ECMO) systems.

! WARNING !

Epidural administration of drugs other than those indicated for epidural use could result in serious injury to the patient.

- Epidural administration of anesthetics is limited to short term infusion (not to exceed 96 hours) with indwelling catheters specifically indicated for short term anesthetic epidural drug delivery.
- Epidural administration of analgesics is limited to use with indwelling catheters specifically indicated for either short term or long term analgesic epidural drug delivery.
- To prevent infusion of drugs not indicated for epidural use, do not use administration sets incorporating injection sites during epidural delivery.
- Clearly distinguish pumps used for epidural drug delivery from pumps used for other routes of administration.

Cautions

CAUTION

In the U.S., use of device is restricted by Federal Law (USA) to sale or use by, on the order of, or under the supervision of a physician or other licensed healthcare professional.

CAUTION

Follow the cleaning schedule and methods defined under "Cleaning," 7-1 to ensure proper maintenance of the device.

Power On and PERSONALITY Feature Set Selection

Note: The COLLEAGUE and COLLEAGUE 3 pumps have not been evaluated for use in care areas other than those listed on page 1-11.

1. Press the **ON/OFF CHARGE** key to turn the pump ON. The Main Display prompts to perform a speaker test, which helps ensure alarms and alerts are audible and the volume level is appropriate for the care area.
2. Press and hold the **Speaker Test** soft key until **Yes** and **No** soft keys are displayed (Figure 11-1). The pump produces sound for as long as the **Speaker Test** soft key is pressed.

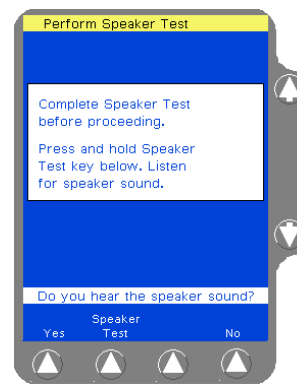

Figure 11-1 Speaker Test Screen

3. Do one of the following:
 - If the tone is heard, press **Yes**. The pump completes self-test and displays the Power On screen.
 - If the tone is not heard, even after adjusting the volume control, press **No**, then press **No** again when prompted to confirm. Do not use the pump.

If the continuous tone is not heard during the speaker test, alarms and alerts may not be audible during operation. Do not use the pump. Send the pump to service.

4. To clear previously programmed information and Volume History, press the **New Patient** soft key.
5. To select a PERSONALITY feature set, press the **Change Personality** soft key. A list of available PERSONALITY feature sets is displayed.

6. Use the $\uparrow\downarrow$ keys to highlight the desired PERSONALITY feature set, then press the **Select** soft key.

If no keys are pressed, the pump automatically displays the Main Display screen after approximately 10 seconds.

Power Off

1. Press the **ON/OFF CHARGE** key to power off the pump. A pop-up window is displayed to confirm that the pump should be powered off. To resume operation, press the **Return** soft key.
2. Press **ON/OFF CHARGE** again to power off the pump.

Loading the Administration Set

! WARNING !

Pulling or tugging on the administration set tubing between the pump channel and the patient may cause false Air Detected alarms, which will cause the pump to stop infusing. In order to reduce the potential for this situation to occur:

- First, select an appropriate length administration set.
- Before loading the set into the pump, position the keyed slide clamp at an appropriate location along the tube segment to ensure that there is adequate length of tubing between the patient and the pump to reduce tugging on the set.
- Lastly, ensure there is sufficient slack in the tubing between the distal end of the tubing channel and the patient to prevent tube tugging during activities such as moving the patient from one bed to another, or transportation of the patient from one facility location to another.

In order to avoid false alarms, the pump should never be placed on the bed alongside the patient.

! WARNING !

Do not allow fluid to enter the tubing channel or load wet tubing into the pump. Contact your Baxter Service Center for assistance immediately if fluid enters the tubing channel. The tubing channel should be cleaned as soon as possible by Baxter-trained, qualified personnel to minimize potential difficulties caused by fluid pooling and drying on the mechanism. Fluid in the tubing channel can also cause false Air In Line alarms.

CAUTION

When attempting to load or unload an administration set, do not insert tools or other objects into the tubing channel.

1. For single channel pumps, press the **Open** key.
For triple channel pumps, press the **Channel Select** key for the desired channel, then press the **Open** key.

The automatic tube loading mechanism will open. The pump module displays **PATIENT** alternating with **---->>>>**.

2. Close the keyed slide clamp on the administration set so it occludes the tubing.

3. Hold the tubing so the fluid path is from left to right (Figure 11-2a), and insert the keyed slide clamp into the keyed slot on the left-hand side of the tubing channel (Figure 11-2b).

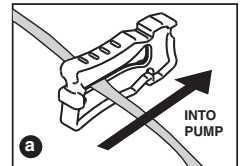

4. Pull the tubing taut and slide it all the way into and along the tubing channel (Figure 11-2c). The pump pulls in the keyed slide clamp, then loads the administration set into the pumping mechanism (Figure 11-2d). The pump module displays **LOADING** and then **STOPPED**.

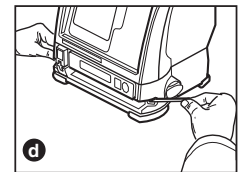
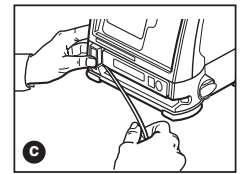
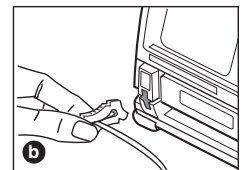

Note: A **Tube Misloaded** alarm will occur if the tubing is not loaded properly.

5. Open the regulating clamp. Verify that no solution is flowing.
6. Attach the primed administration set to the patient access site.
7. For triple channel pumps only: Arrange the tubing in the tubing guide according to pump channel.

Figure 11-2 Loading the Administration Set

! WARNING !

If flow is observed when tubing is loaded but the pump is not running, close the regulating clamp immediately. Ensure that all steps have been properly performed. If flow is still observed, remove the pump from service and contact Baxter-trained, qualified personnel.

Programming a Primary Rate-Volume Infusion

Note: If the pump status is unclear, close any pop-up windows on the display and press the **Main Display** key to continue.

1. For single channel pumps: press the **Primary** soft key.
For triple channel pumps: press the desired **Channel Select** key.

The Main Display shows the Primary Rate-Volume programming screen, and the **Rate** field is highlighted (Figure 11-3).

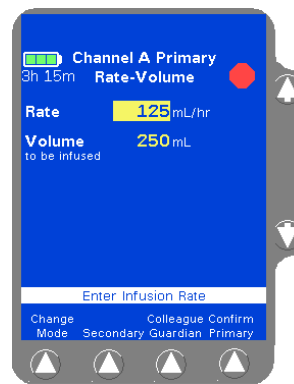

Figure 11-3 Rate-Volume Programming Screen

! WARNING !

There may be periods of no flow for flow rates less than or equal to 1mL/hr.

2. Enter the flow rate using the numeric keypad.
3. Press the **Vol** key or use the $\uparrow\downarrow$ keys to highlight the **Volume to be infused (VTBI)** field.

! WARNING !

Do not enter a **Volume to be infused** greater than the amount of fluid available in the container.

4. Enter the VTBI using the numeric keypad.
5. Press the **Confirm Primary** soft key.
6. Press **START** to start the infusion. The green RUNNING LED will illuminate on the pump channel and a moving drop icon will appear on the Main Display.

Confirm that flow is occurring by observing drops falling into the drip chamber.

Selecting a Label

1. For single channel pumps: press the **Primary** soft key.
For triple channel pumps: press the desired **Channel Select** key.
2. Press the **Change Mode** soft key. The Programming Modes Menu is displayed.
3. Highlight **Label Line** (under **Functions**) using the $\uparrow\downarrow$ keys, then press the **Select** soft key.

A list of labels and their abbreviations is displayed (Figure 11-4).

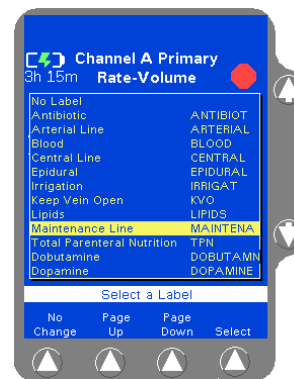

Figure 11-4 Label List

4. Use the $\uparrow\downarrow$ keys and/or the **Page Up** and **Page Down** soft keys to highlight the appropriate label, then press the **Select** soft key. When the **Select** soft key is pressed, the Programming screen is displayed, showing the selected label.

Note: Labels configured using the COLLEAGUE GUARDIAN feature do not appear in the label list.

To clear a label, use the same procedure, but select **No Label** from the label list. **No Label** always appears first in the label list.

Confirm that the selected label is appropriate for the medication/solution infusing on that channel.

To add or change a label after the infusion is already running, first stop the infusion by pressing the **STOP** key. After following the steps above, press **START** to resume the infusion.

Programming a Primary Volume-Time Infusion

1. For single channel pumps: press the **Primary** soft key.
For triple channel pumps: press the desired **Channel Select** key.
2. Press the **Change Mode** soft key. The Programming Modes Menu is displayed.
3. Highlight **Primary Volume-Time**, then press the **Select** soft key. The Volume-Time Programming screen is displayed (Figure 11-5).

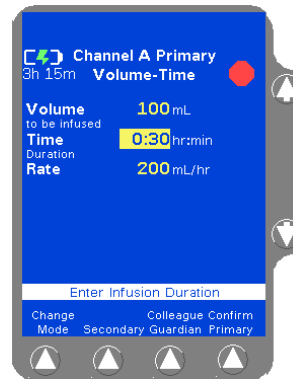

Figure 11-5 Volume-Time Programming Screen

4. Enter the Volume to be infused using the keypad.
5. Highlight **Time Duration** using the $\uparrow\downarrow$ keys. Use the keypad to enter the time period for the infusion in hours and minutes. The pump automatically calculates the flow rate.
6. Press the **Confirm Primary** soft key.
7. Press the **START** key to start the infusion. The green RUNNING LED will illuminate on the pump channel and a moving drop icon will appear on the Main Display.

Confirm that flow is occurring by observing drops falling into the drip chamber.

Programming a COLLEAGUE GUARDIAN Infusion (Rate-Volume)

Note: If the **Colleague Guardian** soft key is not visible at the bottom of the Programming screen, this feature is not enabled.

1. For single channel pumps: press the **Primary** soft key.
For triple channel pumps: press the desired **Channel Select** key.
2. Press the **Colleague Guardian** soft key from the Programming screen. The labels for which COLLEAGUE GUARDIAN limits have been defined are displayed in a pop-up window (Figure 11-6).

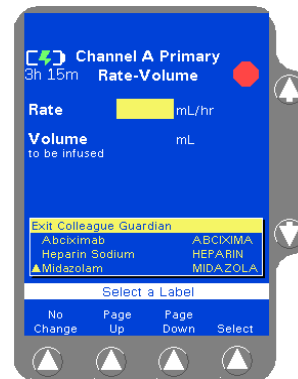

Figure 11-6 Colleague Guardian Label List

3. Use the $\uparrow\downarrow$ keys to highlight the desired label, then press the **Select** soft key.

The programming mode changes to the mode configured for the selected label, and the Rate field is filled with the configured value.

4. Use the \downarrow key to highlight the The **Volume To Be Infused** field.
5. Enter the volume using the numeric keypad.
6. Press the **Confirm Primary** soft key. If the values entered result in a dose that is outside the COLLEAGUE GUARDIAN rate limits, a Limits Warning pop-up is displayed (Figure 11-7).

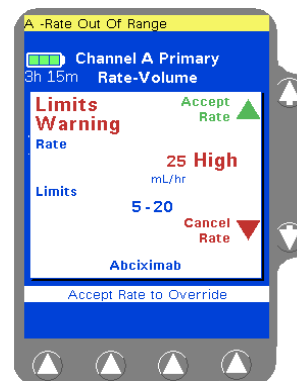



Figure 11-7 Limits Warning Pop-up

If this occurs, do one of the following:

- Press **Cancel Rate** (\downarrow key) to return to the programming screen, then enter a rate that is within the rate limits.

- Press **Accept Rate** (↑ key) to accept the out-of limits flow rate and continue with the infusion as programmed.
7. Press the **START** key to begin the infusion.

COLLEAGUE GUARDIAN infusions are indicated by the mortar and pestle icon  next to the label on the Main Display screen.

Programming a COLLEAGUE GUARDIAN Dose Mode Infusion

1. For single channel pumps: press the **Primary** soft key.
For triple channel pumps: press the desired **Channel Select** key.
2. Press the **Colleague Guardian** soft key. The labels for which COLLEAGUE GUARDIAN limits have been defined are displayed in a pop-up window (Figure 11-8).

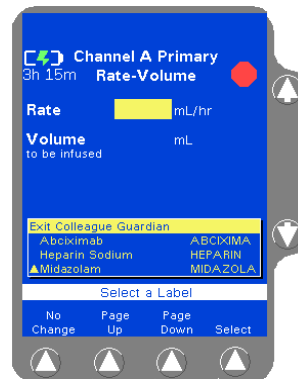

Figure 11-8 Colleague Guardian Label List

3. Use the ↑↓ keys to highlight the desired label, then press the **Select** soft key.

The programming mode changes to the mode configured for the selected label, and the **Drug Amount**, **Diluent Volume**, and **Concentration** fields are filled with the defined values.

- For non-weight-based modes, the **Volume To Be Infused** field is filled with the standard Diluent Volume (Figure 11-9).

- For weight-based modes, the **Weight** field is highlighted (Figure 11-10). If a default dose has been configured, it appears in the **Dose** field.

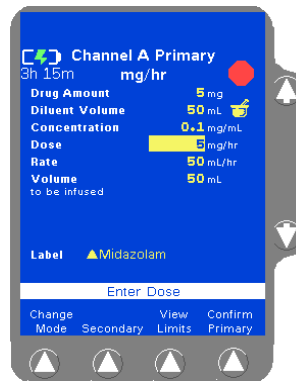

Figure 11-9 Non-Weight-Based Programming Screen

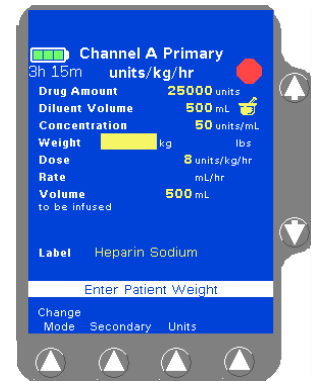

Figure 11-10 Weight-Based Programming Screen

4. For weight-based modes, enter patient weight using the numeric keypad. The pump calculates the values for the remaining fields.

Depending on how the pump has been configured at the facility, the **kg** or **lbs** field may not be available for data entry. Fields not available for data entry appear as shaded.

For small patients, weight can be entered in grams (or ounces) if appropriate. To change weight units, highlight the **Weight** field, press the **Units** soft key to display the weight units list, highlight the desired weight unit, then press the **Select** soft key.

5. (Optional) To view the limits for the label, press the **View Limits** soft key. The Limits Display pop-up displays the preconfigured range limits for rate, dose, or concentration, whichever is appropriate for that label (Figure 11-11). Press the **Done** soft key to close the pop-up.



Figure 11-11 View Limits Pop-up

6. (Optional) If the label is set up to allow non-standard concentration programming, the drug amount, diluent volume, and concentration can be changed by using the $\uparrow\downarrow$ keys to highlight the appropriate field and entering new values using the numeric keypad.
7. Use the \downarrow key to highlight the **Dose** field and enter the dose. The pump displays the dose and calculated flow rate.

If values are changed so that the resulting drug amount, diluent volume, or concentration is non-standard, the changed values are indicated by white triangles beside them (Figure 11-12).

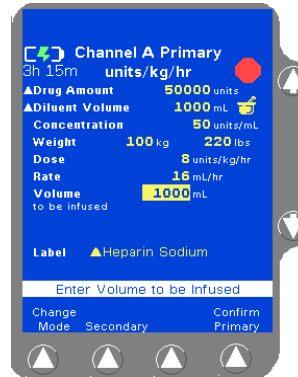

Figure 11-12 Non-Standard Programming (White Triangles)

8. Press the **Confirm Primary** soft key.

If the dose entered is outside the dose limits, a Limits Warning pop-up is displayed (Figure 11-13). Do one of the following:

- Press **Cancel Dose** (\downarrow key) to cancel the dose, then enter a dose that is within the preset limits.
- If the clinical decision is to proceed with the override of the COLLEAGUE GUARDIAN limits, press **Accept Dose** (\uparrow key) to accept the out-of limits dose and continue.

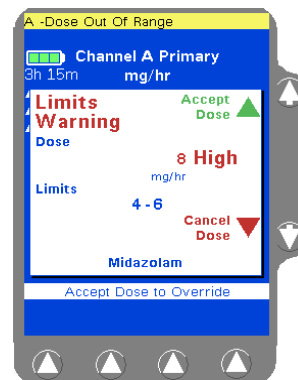



Figure 11-13 Limits Warning Pop-up

9. Press **START** to begin the infusion.

COLLEAGUE GUARDIAN infusions are indicated by the mortar and pestle icon  next to the label on the Main Display screen.

A yellow triangle is displayed beside the label name if the drug amount, diluent, or concentration was changed to deviate from the standard COLLEAGUE GUARDIAN settings.

Note: If the clinical decision was to override the COLLEAGUE GUARDIAN limits, the dose and programming mode are displayed in red on a yellow highlight indicating that the programmed dose is outside of the limits.

Programming a Dose Mode Infusion

1. For single channel pumps: press the **Primary** soft key.
For triple channel pumps: press the desired **Channel Select** key.
2. Press the **Change Mode** soft key. The Programming Modes Menu is displayed.
 - Use the $\uparrow\downarrow$ keys and/or the **Page Up** and **Page Down** soft keys to highlight the appropriate dose mode, then press the **Select** soft key. The Dose Programming screen is displayed, with programming fields for either a non-weight based mode (Figure 11-14) or a weight-based mode (Figure 11-15) as appropriate.

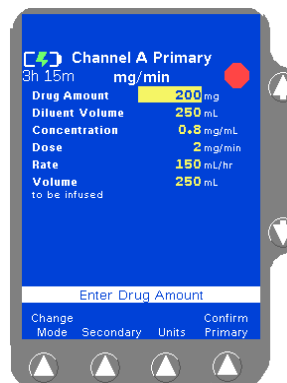

Figure 11-14 Non-Weight-Based Programming Screen



Figure 11-15 Weight-Based Programming Screen

3. Use the $\uparrow\downarrow$ keys to move through the programming screen. Enter the drug amount, diluent volume, and the dose or rate.

4. For weight-based modes, enter patient weight in kg (or lbs) using the numeric keypad. The pump calculates the values for the remaining fields.

For small patients, weight can be entered in grams (or ounces) if appropriate. To change weight units, highlight the **Weight** field, press the **Units** soft key to display the weight units list, highlight the desired weight unit, then press the **Select** soft key.

5. Press the **Confirm Primary** soft key.
6. Press **START** to begin the infusion.

Programming a Secondary Rate-Volume Infusion

1. For single channel pumps: press the **Secondary** soft key.
For triple channel pumps: press the desired **Channel Select** key, then press the **Secondary** soft key.

The Main Display shows the Secondary Rate-Volume programming screen, and the **Rate** field is highlighted.

! WARNING !

There may be periods of no flow for flow rates less than or equal to 1mL/hr.

2. Enter the flow rate using the numeric keypad.
3. Press the **Vol** key or use the $\uparrow\downarrow$ keys to highlight the **Volume to be infused (VTBI)** field.

! WARNING !

Do not enter a **Volume to be infused greater than the amount of fluid available in the container.**

4. Enter the VTBI using the numeric keypad.
5. Press the **Confirm Secondary** soft key.
6. If the primary set has a slide clamp above the pump, close the slide clamp.
7. Open the On/Off clamp on the secondary medication/solution set and press the **START** key.

Confirm that flow is occurring by observing drops falling into the drip chamber. Delivery from the primary container will occur when the secondary container empties.

Note:
Open Primary Slide Clamp If the primary administration set has a slide clamp above the pump, when the secondary infusion has completed, open the slide clamp above the pump to restart the primary infusion.

Programming a Secondary Volume-Time Infusion

1. For single channel pumps: press the **Secondary** soft key.
For triple channel pumps: press the desired **Channel Select** key, then press the **Secondary** soft key.
2. Press the **Change Mode** soft key. The Programming Modes Menu is displayed.
3. Highlight **Secondary Volume-Time**, then press the **Select** soft key. The Volume-Time Programming screen is displayed (Figure 11-5).
4. Enter the **Volume to be infused** using the keypad.
5. Highlight **Time Duration** using the $\uparrow\downarrow$ keys. Use the keypad to enter the time period for the infusion in hours and minutes. The pump automatically calculates the flow rate.
6. Press the **Confirm Secondary** soft key.
7. If the primary set has a slide clamp above the pump, close the slide clamp.
8. Open the On/Off clamp on the secondary medication/solution set and press the **START** key.

Confirm that flow is occurring by observing drops falling into the drip chamber. Delivery from the primary container will occur when the secondary container empties.

Note: If the primary administration set has a slide clamp above the pump, when the secondary infusion has completed, open the slide clamp above the pump to restart the primary infusion.

Open Primary
Slide Clamp

Standby Mode

For single channel pumps:

1. Ensure the pump is stopped.
2. (Optional) To preprogram the pump for future use, program the infusion (but do not press the **START** key).
3. From the Programming screen, press the **Change Mode** soft key.

4. Use the $\uparrow\downarrow$ keys to highlight **Standby**, then press the **Select** soft key. The Standby pop-up is displayed (Figure 11-16).

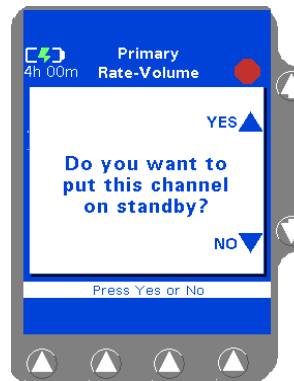

Figure 11-16 Standby Pop-up

5. Press the \uparrow key next to the **YES** shown on the pop-up to place the pump into Standby mode.

For triple channel pumps:

1. Ensure the pump channel is stopped. Press the **Channel Select** key for the channel to be put on Standby.
2. (Optional) To preprogram the channel for future use, program the infusion (but do not press the **START** key).
3. Press the **Channel Select** key again. The Standby pop-up is displayed.
4. Press the \uparrow key next to the **YES** shown on the pop-up to place the channel into Standby mode.

To exit Standby:

1. For single channel pumps: press the **Primary** soft key.
For triple channel pumps: press the desired **Channel Select** key.

The pump channel exits Standby and reverts to the programming mode in effect when it was placed on Standby.

Unloading the Administration Set

Automatic Unloading

1. If the pump module is running, press the **STOP** key on the pump module to stop it.
2. **Close the regulating clamp on the administration set.**
3. Press the **Open** key on the pump module. The mechanism closes the keyed slide clamp and opens the tubing channel. When an arrow is displayed on the pump module, the tubing channel is open.

! WARNING !

While the pump automatically closes the keyed slide clamp, always close the regulating clamp on the administration set before loading or removing the administration set from the pump.

CAUTION

When attempting to load or unload an administration set, do not insert tools or other objects into the tubing channel.

4. Grasp the administration set on both sides of the pump and remove it from the tubing channel. The mechanism closes automatically 60 seconds after the administration set has been removed.

Note: Do not cut the tubing to remove the administration set from the channel. If the tubing is cut, remove the slide clamp immediately.

Using the Manual Tube Release (MTR)

Use Manual Tube Release only when the Tube Loading Mechanism is NOT functioning, or if a channel failure occurs. The MTR feature is for emergency use. Never use the MTR to load or unload the administration set during normal operation.

Note: The pump will not turn on if the MTR is in the open position.

For triple channel pumps: If the MTR is used, the remaining pump channels cannot be programmed until the MTR is reset.

1. **Close the regulating clamp on the administration set.**
2. Locate the appropriate Manual Tube Release on the right side of the pump channel.
3. Push and grasp the release tab (Figure 11-17A), turning it out (Figure 11-17B).
4. Rotate the tab counterclockwise until it stops (Figure 11-17C).

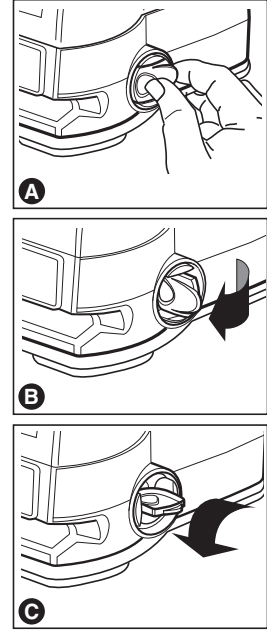

Figure 11-17 Using the MTR

- Note:** If the pump is off when the MTR is activated, it will automatically turn itself on. The **Reset Manual Tube Release** alarm occurs and the **Reset Manual Tube Release** screen displays
5. This closes the keyed slide clamp and opens the pump mechanism so the administration set can be removed.
 6. Remove the administration set from the pump.

If the pump is on with no administration set in the tubing channel, a **Reset Manual Tube Release** alarm occurs.

If the pump is on and the administration set is in the tubing channel when the MTR is activated, a **Close Regulating Clamp** alarm occurs. **Close the regulating clamp on the administration set**, remove the administration set, and then reset the mechanism.

Resetting the Manual Tube Release

If a channel failure occurs and an attempt is made to power off the pump without first resetting the MTR, the **Reset Manual Tube Release** pop-up is displayed (Figure 11-18).

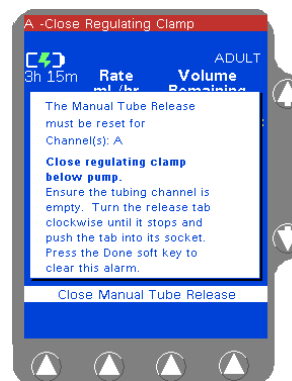

Figure 11-18 Reset MTR Pop-up

Reset the Manual Tube Release as follows:

1. **Close the regulating clamp on the administration set.** Ensure there is no administration set or foreign object in the tubing channel.
2. Turn the release tab (Figure 11-17A) clockwise until it stops and push the tab into its socket. For triple channel pumps: Repeat the steps above as needed for additional channels.
3. Press the **Done** soft key to clear the alarm.

Note: If the MTR is used following a channel failure to remove the administration set, the pump cannot be powered off until the MTR has been reset. A Reset Manual Tube Release pop-up message will be displayed.

Note: If three unsuccessful attempts to reset the MTR are made, a channel failure occurs. The pump cannot be used until the MTR is reset and the pump is powered off and back on.

Troubleshooting Failures

Device Failure

Device failures affect all infusions running on the device. When a device failure has occurred, follow the directions below:

1. **Close the regulating clamp on the administration set.** Unload the administration set.
2. Request a replacement pump immediately.
3. Cycle power on the pump by powering off and then powering on again. Do this only once.
4. Based on the result, do one of the following:
 - If the failure code recurs after the pump is turned back on, stop using the pump.
 - If the failure code does not recur after the pump is turned back on, re-load the administration set into the same channel, open the regulating clamp, and continue using the pump.
5. Monitor the pump until replacement pump arrives and transfer any infusions to the replacement pump as soon as it is clinically safe. Have the failed pump serviced as soon as possible.

Channel Failures

! WARNING !

While the pump automatically closes the keyed slide clamp, always close the regulating clamp on the administration set before loading or removing the administration set from the pump.

Note: If Failure Code 803:07 occurs, ensure that the slide clamp has been removed from the pump. Do not cut the tubing to remove the administration set from the channel. If the tubing is cut, remove the slide clamp immediately.

1. For single channel pumps: press the **Primary** or **Secondary** soft key. For triple channel pumps: press the desired **Channel Select** key.
2. For single channel pumps: request a replacement pump immediately.
3. Perform step 4 or 5 as appropriate.

4. If the tube loading mechanism is open, **close the regulating clamp on the administration set** and remove the set. Press the **Done** soft key. The channel is now shown as **Out Of Service**.

For single channel pumps: the pump cannot be used to deliver infusions, but the **Volume History** key can be used to retrieve history information. Skip to step 6.

5. If the channel fails with the tube loading mechanism in the “closed” position:
 - **Close the regulating clamp on the administration set.** Press the **Open** key. If the mechanism opens, remove the set.
 - If the mechanism does not open, use the MTR to remove the set.
6. Press the **Done** soft key. The Main Display shows that the pump is out of service.
7. Do one of the following:
 - For single channel pumps, cycle power on the pump by powering off and then powering on again. Do this only once. Proceed to step 8.
 - For triple channel pumps, allow any infusions running on the other pump channels to complete. Remove the pump from service and have it inspected by Baxter-trained, qualified personnel as soon as possible. Do not continue with this procedure.
8. Based on the result, do one of the following:
 - If the failure code recurs after the pump is turned back on, stop using the pump.
 - If the failure code does not recur after the pump is turned back on, re-load the administration set into the same channel, open the regulating clamp, and continue using the pump.
9. Monitor the pump until replacement pump arrives and transfer any infusions to the replacement pump as soon as it is clinically safe. Have the failed pump serviced as soon as possible.

Troubleshooting Alarms

An alarm will override an existing alert condition. The alarm tone can be silenced for two minutes by pressing the **Alarm Silence** key.

Air Detected

Pump module display message: AIR

Cause: An air bubble detected in the administration set.

Action: For single channel pumps: proceed directly to step 2.

1. For triple channel pumps: press the **Channel Select** key to access the appropriate programming screen. A pop-up window is displayed.
2. You have two options:
 - Press the \downarrow key next to the **NO** selection, unload the tubing, then manually purge the air. Properly reload the tubing after the air is purged.
 - Press the \uparrow key next to the **YES** selection, then press and hold the **Advance Air** soft key. When the pump detects fluid, a fluid detected icon is displayed. Press the **Done** soft key. The **Air Detected** alarm is reset. Visually inspect the air and follow your care area's procedures for manually removing the air.

Note: The **Advance Air** alert is active when the **Advance Air** soft key is pressed. This alert clears when the **Done** soft key is pressed.
3. To restart the infusion, press **START**.

Downstream Occlusion

Pump module display message: DWN OCCL/label

Cause: A closed clamp, stopcock, clogged filter or other occlusion is preventing fluid flow between the pump and patient.

Action: Correct the problem causing the occlusion.

After correcting the problem, press the appropriate **Channel Select** key (for a triple channel pump), press the **Primary** or **Secondary** soft key, then press the **START** key to resume the infusion.

Note: When the pump is configured with the Auto Restart feature ON, the pump can automatically restart if the occlusion is resolved within one minute after detection. Auto Restart will be disabled if any key is pressed during a Downstream Occlusion alarm.

NO BATTERY - Plug in Now

Pump module display message: current infusion information

Cause: The batteries are depleted and infusions have stopped. The pump must be plugged into AC power before infusions may be restarted. After 5 minutes in this alarm state, the pump will shut down.

Action: To clear the alarm, plug into AC power immediately. A pop-up is displayed, instructing not to unplug the pump. Press the **Ok** soft key to clear the pop-up and resume the infusion using AC power.

- To resume infusions on single channel pumps: press the **START** key.
- To resume infusions on triple channel pumps: press the **Channel Select** key(s), then press the **START** key.

Do not use the pump on battery power until the battery charge icon indicates that the batteries have fully charged.

If infusions are complete, power off the pump by pressing the **ON/OFF CHARGE** key twice and allow the batteries to recharge fully.

Tube Misloaded

Pump module display message: PATIENT ---->>>>

Cause:

- The administration set has been improperly loaded.
- The administration set was not fully removed from the tubing channel.
- A hardware problem may have occurred.

Action:

- Close the regulating clamp on the administration set and remove the administration set. Reload the set.
- If alarm occurs again, a hardware problem may exist. Take the pump out of service and have it inspected by Baxter-trained, qualified personnel.

Upstream Occlusion

Pump module display message: UFOCCCL/label

Cause: A closed clamp, obstruction, or kink in the administration set is preventing fluid flow between the source container and the pump.

Action: Correct the problem causing the occlusion.

- Ensure the complete insertion of the spike into the source container.
- Inspect the administration set above the pump for closed clamps or kinks.
- Ensure that BURETROL administration sets or source containers are vented.

After correcting the problem, press the appropriate **Channel Select** key (for a triple channel pump), press the **Primary** or **Secondary** soft key, then press **START** to resume the infusion.

Troubleshooting Alerts

The alert tone can be silenced for two minutes by pressing the **Alarm Silence** key.

Advance Air

Pump module display message: ADV AIR

Cause: The pump's Advance Air feature is being used to move an air bubble through the tubing.

Action: The **Advance Air** alert is active when the **Advance Air** soft key is pressed. This alert clears when the **Done** soft key is pressed.

Channel Stopped

Pump module display message: STOPPED

Cause: The pump is ON and the infusion is not running.

Action: Complete the remaining programming steps and press the **START** key, or power off the pump.

LOW Battery - Plug in Now

Pump module display message: the current infusion information

Cause: The charge remaining in the batteries has 30 minutes of infusion time left. The time remaining shown on the Main Display decrements if the pump is not plugged in.

Action: Plug the pump into an AC power source as soon as possible.

KVO: Volume Remaining = 0

Pump module display message: KVO=x.x/label
(where x.x = the KVO rate)

Cause: The Volume to be infused has reached zero and the pump is infusing at the KVO rate (or programmed rate, whichever is lower).

Action: Do one of the following as appropriate:

- Prepare a new infusion.
- For triple channel pumps, stop the channel and place it in Standby mode.
- Power off the pump.

Index

A

- abbreviations used in label library list 6-7
- ac power requirements 9-1
- accessories
 - COLLEAGUE DL2 Event History Download Application 5-2
 - COLLEAGUE GUARDIAN Configuration Tool 5-2
 - syringe adapter 5-1
- accuracy
 - data 9-6
 - tests 9-9
- administration sets 9-1
 - preparation 4-13
 - preparing secondary 4-49
 - unloading after pump failure 8-3, 8-6
- advance air alert 8-17
- advance air, flow rate during 9-2
- air bubble setting 9-2
- air detected alarm 8-9
- air detection
 - flow rate during advance air 9-2
- air removal
 - manual 8-10
 - pump-assisted 8-10
- air sensor 9-2
- alarm messages
 - air detected 8-9
 - close regulating clamp 8-13
 - damaged battery 8-8, 8-13
 - downstream occlusion 8-13
 - incomplete primary program 8-13
 - incomplete secondary program 8-13
 - no battery - plug in now 8-14
 - panel lockout button stuck 8-14
 - primary out of range 8-14
 - reset manual tube release 8-14
 - secondary out of range 8-14
 - silencing 8-7
 - stuck key detected 8-15
 - temperature too high 8-15
 - temperature too low 8-15
 - troubleshooting 8-7
 - tube loading 8-15
 - tube misloaded 8-15
 - tube not loaded 8-15
 - unconfirmed primary program 8-15
 - unconfirmed secondary program 8-15
 - upstream occlusion 8-16
- alarm silence key 2-4
- alarms, battery-related 4-10
- alert messages
 - advance air 8-17
 - battery approaching end of life 8-17
 - changing primary program 8-17
 - changing secondary program 8-17
 - channel stopped 8-17
 - charge progress 8-17
 - confirm power off 8-18
 - damaged battery 8-18
 - depleted battery 8-18
 - description 8-16
 - dose out of range 8-19
 - incomplete primary program 8-19
 - incomplete secondary program 8-19
 - KVO 8-20
 - limited battery 8-19
 - lithium battery low 8-19
 - low battery - plug in now 8-20
 - prime 8-20
 - programming secondary 8-20
 - rate out of range 8-21
 - release panel lockout button 8-21
 - running on battery 8-21
 - secondary callback 4-56, 8-21
 - stuck key detected 8-21
 - troubleshooting 8-16
 - unconfirmed primary program 8-22
 - unconfirmed secondary program 8-22
- alerts, battery-related 4-10, 4-12
- application labels 6-9
- application labels included in label library 6-9
- applying power 4-1
- authorized service centers 10-2
- auto restart 4-84
 - description 9-3

B

- back light key 2-4, 8-1
- battery 4-8
 - charge icons 4-8
 - charging 7-3, 7-5
 - damaged battery 2-15, 4-9

- damaged battery alarm 8-8
- discharge 4-8
- disposal 7-3, 7-6
- icon 2-5
- operating time specifications 9-1
- operation 4-8, 7-3
- service life 7-4
- battery approaching end of life alert 8-17
- battery charge 2-14
- battery charge icon 2-14, 4-8
- battery charge icons 4-8
- battery charge progress indicator 4-12
- battery-related alarms 4-10
- battery-related alerts 4-10, 4-12
- Baxter customer service website 10-2
- bolus volume after clearing occlusions 9-13

C

- cables
 - COLLEAGUE communication cable 9-5
 - configuration transfer cable 9-4
- care sites 1-11
- cautions, general 1-9, 11-2
- changing dose during an infusion 4-69
- changing dose programming parameters 2-25
- changing flow rate during an infusion 4-68, 4-73
- changing mounting clamp position 3-3
- changing primary program alert 8-17
- changing secondary program alert 8-17
- channel failure 8-5
 - pop-up 8-3
 - resetting manual tube release after 8-4, 8-6
 - unloading administration set 8-3, 8-6
- channel failure pop-up 8-5
- channel select key 2-7
- channel stopped alert 8-17
- charge progress alert 4-12, 8-17
- charge progress indicator 4-12
- charging icon 2-15, 4-9
- charging the batteries 7-5
- charging the battery 7-3
- check-out 3-3
- cleaning 7-1
 - approved cleaners 7-2
- clear key 2-5
- clearing volume history 4-67
- clinician override 4-84

- close regulating clamp alarm 8-13
- COLLEAGUE communication cable 9-5
- COLLEAGUE DL2 Event History Download Application 5-2
- COLLEAGUE GUARDIAN Configuration Tool 5-2
- COLLEAGUE GUARDIAN feature
 - changed dose icon (triangle) 2-16
 - description 2-21
 - guidelines for using 2-22
 - icon 2-16, 2-23
 - icon while running 4-30, 4-33, 4-38
 - indication of limit override 4-30, 4-33, 4-38
 - prerequisites for using 2-21
 - programmable parameters, list of 6-3
 - triangle indicator in label list 4-28, 4-31, 4-34
- communication port 2-9, 9-4
- completing a primary infusion 4-77
- computer control icon 2-5
- configurable options 6-1
 - callback alert 4-56
 - general pump options 6-2
- configuration transfer cable 9-4
- configuration/service 4-86
- configuration/service function 4-86
- confirm power off alert 8-18
- container preparation 4-13
- contrast control 2-9
- custom labels 6-10

D

- damaged battery alarm 8-8, 8-13
- damaged battery alert 8-18
- damaged battery icon 2-15, 4-9
- darkened screen 8-1
- delay start 4-62
 - icon 2-16
 - programmable delay time period 9-3
- delivery accuracy 9-6
- depleted battery alert 8-18
- description
 - COLLEAGUE GUARDIAN feature 2-21
 - icons 2-5
 - keys 2-4
 - LEDs 2-7
 - main display 2-6, 2-10
 - main display icons 2-14
 - menus 2-14
 - numeric keypad 2-5
 - pop-up defined 2-14
 - programming screens 2-13
 - pump labels 2-17
 - pump module display 2-6

- pump module keys 2-7
- rear panel features 2-9
- serial number 1-6
- device failure 8-2, 11-20
- diluent volume 4-40, 4-45
- dimensions of pump 9-3
- display
 - darkened 8-1
 - illustration 2-12
 - main 2-6
 - more than one screen 2-16
 - pop-up window 2-11
 - pump module 2-6
- disposal requirements 1-4, 1-5
- disposing of batteries 7-3
- DL2 Event History Download Application 5-2
- dose out of range alert 8-19
- dose programming
 - available formulas 4-43
 - based on patient weight 4-43
 - changing a parameter 2-25
 - clearing parameters from memory 4-44
 - entering diluent volume 4-40, 4-45
 - entering dose 4-40, 4-45
 - entering VTBI 4-41, 4-46
 - independent of patient parameters 4-39, 4-43
- dose, changing during an infusion 4-69
- downstream occlusion alarm 8-13
- downstream occlusion alarm level 4-84, 6-5, 9-3
- downstream occlusion level 4-83, 4-84
- drop icon 2-15

E

- electromagnetic compatibility 9-14
- enabling standby mode 4-57, 4-58
- entering diluent volume 4-40, 4-45
- entering dose 4-40, 4-45
- entering drug amount 4-40
- entering volume to be infused 4-50
- environmental operating limits 9-3
- environmental storage specifications 9-4
- epidural infusion warning 1-7, 11-2
- exiting standby 4-60

F

- failure
 - channel 8-5
 - device 8-2, 11-20
 - messages 8-2
 - troubleshooting 8-2

- feature list 1-1
- flow check
 - description 2-14
 - display 4-85
 - icon 2-15
- flow rate
 - changing 4-68, 4-73
 - during advance air 9-2
 - during priming 9-2
 - range specifications 9-2
- fluid icon 2-14
- formulas for dose programming 4-43
- front panel illustration 2-2
- fuse holders 2-9
- fuses 9-1

G

- general cautions 1-9, 11-2
- general warnings 1-7, 11-2
- graphs
 - startup 9-7
 - trumpet curve 9-8
- ground impedance specification 9-4

H

- headboard mounting of pump 3-2
- history 4-67
- how to check downstream resistance to flow 4-85

I

- icons 2-5
 - air 2-14
 - battery 2-5
 - battery charge 2-14, 4-8
 - changed dose (triangle) 2-16
 - charging 2-15, 4-9
 - COLLEAGUE GUARDIAN feature (mortar and pestle) 2-16, 2-23
 - computer control 2-5
 - damaged battery 2-15, 4-9
 - delay start (wristwatch) 2-16
 - description 2-5
 - flow check 4-85
 - lock 4-74
 - main display 2-14
 - monitor 2-5
 - plug 3-1
 - Plug In 2-15, 4-9
- IEC 60601-1 1-3
- IEC 60601-2-24 1-3, 9-7, 9-8
- illustration
 - changing mounting clamp orientation 3-3
 - front of pump 2-2

- label locations 2-17
- programming modes menu 2-14
- programming screen 2-13
- rear panel 2-9
- using manual tube release 4-79
- incomplete primary programming alarm 8-13
- incomplete primary programming alert 8-19
- incomplete secondary alarm 8-13
- incomplete secondary alert 8-19
- Indications for use 1-10
- infusion
 - secondary 4-48
 - stopping 4-76
 - stopping before completion 4-76
- installation 3-1
- interfaces
 - COLLEAGUE communication cable 9-5
 - configuration transfer cable 9-4
- international standards 1-3
- IV pole mounting 3-2

K

- keypad
 - description 2-5
 - locking 4-74
- keys
 - alarm silence 2-4
 - back light 2-4, 8-1
 - channel select 2-7
 - clear 2-5
 - description 2-4
 - main display 2-4
 - on/off 2-4
 - pump module 2-7
 - rate 2-4
 - silence key 8-7, 8-17
 - soft 2-11
 - start 2-4
 - stop 2-7
 - volume history 2-4, 4-67
- KVO
 - display, defined 4-77
 - programmable range 9-2
 - secondary 4-52, 4-55

L

- label library 2-20
 - application labels 6-9
 - custom labels 6-10
 - predefined labels, list of 6-7
 - pump channel abbreviations, list of 6-7
- label list screen 4-24, 4-71
- labeling
 - information and locations 2-17
 - label part numbers 2-17
 - symbol definitions 1-4

- labels
 - adding after programming 4-71
 - application 6-9
 - selecting for display 4-24
- leakage current 9-1
- LEDs 2-7
- library, pump labels 2-20
- limit override indication while running 4-30, 4-33, 4-38
- limited battery alert 8-19
- lithium battery low alert 8-19
- location of pump labels 2-17
- location of speakers 2-9
- lock icon 2-15, 4-74
- locking the keypad 4-74
- low battery - plug in now alert 8-20

M

- main display
 - description 2-10
 - icons 2-14
 - information areas 2-11
 - key 2-4
- maintenance 7-2
- manual tube release
 - location 2-9
 - resetting 4-80, 11-19
 - resetting after channel failure 8-4, 8-6
 - screen 4-80, 11-19
 - using 4-79, 11-17
 - using during channel failure 8-3, 8-5
- manually purging air in tubing 8-10
- maximum infusion pressure 9-12
- menus 2-14
- monitor icon 2-5
- mortar and pestle icon 2-16, 2-23, 4-30, 4-33, 4-38
- mounting clamp
 - changing orientation 3-3
 - headboard mount 3-2
 - IV pole mounting 3-2
 - location 2-9

N

- no battery - plug in now alarm 8-14

O

- occlusion
 - bolus volume released following 9-13
 - maximum pressure 9-12
 - time to detect 9-12
- on/off key 2-4
- open key 2-7

operating on battery power 4-8
operating temperature 8-15
options
 auto restart 4-84
 clinician override 4-84
 COLLEAGUE GUARDIAN feature 6-3
 configuration/service 4-86
 configuration/service function 4-86
 flow check display 4-85
 prime function 4-18
 specific to PERSONALITY feature sets 6-4
 viewing current PERSONALITY feature set 4-85
 volume-time programming 2-21
options menu
 exiting 4-83
 using 4-82

P

panel lockout 4-74
panel lockout button 2-9
panel lockout button stuck alarm 8-14
panel, rear. See rear panel.
passcode 4-86
patient weight
 entry units 9-2
 specifications for programming 9-2
PERSONALITY feature sets
 configurable options, list of 6-4
 overview 2-19
 viewing current 4-85
plug icon 3-1
Plug In icon 2-15, 4-9
pop-up
 advance air 8-10
 channel failure 8-3, 8-5
 defined 2-11
 panel locked 4-74
 prime active 4-20
 prime warning 4-20
 standby 4-57, 4-58
pop-up window 2-14
power cord specifications 9-1
power off procedure 4-81
power on screen 4-4
power on tests, speaker 4-3
powering on the pump 4-1
preparing secondary infusions 4-49
preparing the infusion container 4-13
pressure maximum 9-12
preventive maintenance 7-2
primary infusion 4-21

primary out of range alarm 8-14
prime alert 8-20
priming 4-18
 flow rate during 9-2
product features 1-1
programming
 dose based on patient weight 4-43
 for future use 4-57, 4-58
 primary rate-volume infusion 4-21
 secondary infusion 4-48
 secondary infusions 4-50, 4-52
 secondary rate-volume infusions 4-50
 secondary volume-time infusions 4-52
 volume-time 2-21
programming modes menu, illustration 2-14
programming screen description 2-13
programming secondary alert 8-20
pump
 failure 8-2
 general configuration options 6-2
 icon 2-5
 labeling locations 2-17
 labels 2-17
 setup 3-1
 specifications 9-1
pump assisted air removal 8-10
pump module
 keys 2-7
 LEDs 2-7
 symbols 2-7
pump weight specifications 9-3

R

rate
 during advance air 9-2
 during priming 9-2
rate key 2-4
rate out of range alert 8-21
rate range specifications 9-2
rate-volume programming screen 4-22
rear panel
 description 2-9
 illustration 2-9
recommended administration sets 4-15
release panel lockout button alert 8-21
releasing tubing manually 4-79
reset manual tube release
 after channel failure 8-4, 8-6
 alarm 8-14
 procedure 4-80, 11-19
resetting manual tube release after channel failure 8-6
restoring a darkened screen 8-1

return shipping information 10-2

running on battery alert 8-21

S

safety

definition of warnings and cautions 1-6

summary 1-3

screen, darkened 8-1

screens

advance air pop-up 8-10

advancing air 8-10

clear stored settings 4-44

confirm primary prompt 4-26, 4-41, 4-46

confirm secondary prompt 4-51, 4-54

enter drug amount 4-40

enter new rate 4-68, 4-73

enter secondary VTBI 4-50

enter time duration 4-25, 4-53, 11-8, 11-15

enter volume to be infused 4-50

entering VTBI 4-41, 4-46

fluid detected 8-11

front panel locked pop-up 4-74

infusion stopped 4-76

KVO display 4-77

label line soft key 4-24, 4-71

label list 4-24, 4-71

main display 4-4

main display with primary running 4-23, 4-60

maximum advance air volume pumped 8-12

new rate running 4-68, 4-73

occlusion alarm level 4-84

power on 4-4

prime active 4-20

programming modes 4-39

rate-volume programming 4-22

ready to prime 4-20

reset manual tube release 4-80, 11-19

secondary stopped 4-76

select secondary callback 4-56

units change list 4-40

value high prompt 4-40, 4-45

value HIGH relieved 4-40, 4-45

volume history 4-67

volume-time programming 4-25, 4-53, 11-8, 11-15

secondary 2-14

callback alert 4-56

icon 2-15

preparing administration set 4-49

programming 4-48

setting up 4-49

stopping 4-76

VTBI 4-50

secondary infusions 4-48

programming 4-50, 4-52

secondary out of range alarm 8-14

selecting a label 4-24, 4-71

self-diagnostic testing 4-2

serial number 1-6

service information 10-2

setting up a secondary infusion 4-49

setting up the pump 3-1

silence key 8-7, 8-17

silencing alarm tones 8-7

soft key 2-11

speaker test 4-3

specifications 9-1

environmental 9-3

flow rate range 9-2

technical 9-1

standards

IEC 60601-1 1-3

IEC 60601-2-24 1-3, 9-7, 9-8

standby

deactivation 4-60, 4-61

enabling 4-57, 4-58

exiting 4-60

pop-up 4-57, 4-58

programming for future use 4-57, 4-58

single channel pumps 4-57

starting an infusion after 4-60, 4-61

triple channel pumps 4-58

standby deactivation 4-60

start key 2-4

starting an infusion 4-23, 4-60

starting an infusion after standby 4-60, 4-61

startup graphs 9-7

stop icon 2-15

stop key 2-7

stopping

infusion 4-76

infusions before completion 4-76

primary infusion 4-77

secondary infusions 4-76

storing the pump 7-6

stuck key detected alarm 8-15

stuck key detected alert 8-21

symbols

shown on labeling 1-4

syringe adapter 5-1

T

tamper prevention 4-74

technical specifications 9-1

temperature too high alarm 8-15

temperature too low alarm 8-15

tests, self-diagnostic 4-2

time on battery specifications 9-1

titrating dose 4-69
tracking requirements, U.S. 1-10
transferring configurable settings from one pump to another 9-4
triangle, COLLEAGUE GUARDIAN label list 4-28, 4-31, 4-34
troubleshooting
 advance air alert 8-17
 air detected alarm 8-9
 alarms 8-7
 alerts 8-16
 battery approaching end of life alert 8-17
 changing primary program alert 8-17
 changing secondary program alert 8-17
 channel stopped alert 8-17
 charge progress alert 8-17
 close regulating clamp alarm 8-13
 confirm power off alert 8-18
 damaged battery alarm 8-13
 damaged battery alert 8-18
 darkened screen 8-1
 depleted battery alert 8-18
 dose out of range alert 8-19
 downstream occlusion alarm 8-13
 failures 8-2
 incomplete primary program alarm 8-13
 incomplete primary program alert 8-19
 incomplete secondary program alarm 8-13
 incomplete secondary program alert 8-19
 KVO alert 8-20
 limited battery alert 8-19
 lithium battery low alert 8-19
 low battery - plug in now alert 8-20
 no battery - plug in now alarm 8-14
 overview 8-1
 panel lockout button stuck alarm 8-14
 primary out of range alarm 8-14
 prime alert 8-20
 programming secondary alert 8-20
 pump failures 8-2
 rate out of range alert 8-21
 release panel lockout button alert 8-21
 reset manual tube release alarm 8-14
 running on battery alert 8-21
 secondary callback alert 8-21
 secondary out of range alarm 8-14
 stuck key detected alarm 8-15
 stuck key detected alert 8-21
 temperature too high alarm 8-15
 temperature too low alarm 8-15
 tube loading alarm 8-15
 tube misloaded alarm 8-15
 tube not loaded alarm 8-15
 unconfirmed primary program alarm 8-15
 unconfirmed primary program alert 8-22
 unconfirmed secondary program alarm 8-15
 unconfirmed secondary program alert 8-22
 upstream occlusion alarm 8-16

trumpet curves 9-8
tube loading alarm 8-15
tube misloaded alarm 8-15
tube not loaded alarm 8-15
turning the pump off 4-81
turning the pump on 4-1

U

unconfirmed primary programming alarm 8-15
unconfirmed primary programming alert 8-22
unconfirmed secondary alarm 8-15
unconfirmed secondary alert 8-22
units for entering patient weight 9-2
unloading administration set 4-78
 after channel failure 8-3, 8-6
unlocking the keypad 4-74
upstream occlusion alarm 8-16
user assistance 1-1, 11-1
using the configuration transfer cable 9-4
using the options menu 4-82

V

viewing PERSONALITY feature set 4-85
volume control 2-9
volume history 4-67
 clearing 4-67
 key 2-4, 4-67
 overview 4-67
 viewing 4-67
volume key 2-4
volume to be infused, range specifications 9-2
volume-time programming 2-21
volumetric accuracy 9-6
VTBI, secondary 4-50

W

warning
 epidural infusions 1-7, 11-2
warnings, general 1-7, 11-2
warranty 10-1
weight
 patient 9-2
 pump 9-3
wristwatch icon 2-16

This manual is printed on paper containing a percentage of recycled fiber.



Baxter

 **Baxter Healthcare SA**
8010 Zurich
Switzerland

Made in Singapore by:
Baxter Healthcare SA, Singapore Branch
2 Woodlands Industrial Park D, Street 2
Singapore 737778, Singapore

Baxter Healthcare Corporation
Deerfield, IL 60015 USA

CD071968806

Original Release
04/2013

© Copyright 2013 Baxter Healthcare Corporation. All rights reserved.